

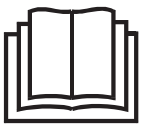

**HYBRID INVERTER**

# **USER MANUAL**

**MODEL NUMBER:  
M1-T(5-10)K**



Warning notices: Before using this product, please read this manual carefully and keep it for future reference. The design and specifications are subject to change without prior notice for product improvement. Consult with your dealer or manufacturer for details. The diagram above is just for reference. Please take the appearance of the actual product as the standard.



## THANK YOU LETTER

Thank you for choosing Midea! Before using your new Midea product, please read this manual thoroughly to ensure that you know how to operate the features and functions that your new appliance offers in a safe way.

## CONTENTS

ABOUT THIS MANUAL .....	02
BASIC SAFETY INFORMATION .....	03
PRODUCT OVERVIEW .....	07
FUNCTION DESCRIPTION .....	13
STORAGE .....	16
INSTALLATION .....	17
ELECTRICAL CONNECTION .....	24
COMMISSIONING .....	37
MAINTENANCE .....	40
HANDLING THE INVERTER .....	46
TECHNICAL DATA .....	47
TRADEMARKS, COPYRIGHTS AND LEGAL STATEMENT	49
DISPOSAL AND RECYCLING .....	50

# 1. ABOUT THIS MANUAL

This manual contains important safety information that must be observed during installation and maintenance of the device.

Carefully read this manual before use and retain it for future reference!

This manual must be treated as an integral component of the device. The manual must be kept in close proximity to the device, including when it is handed over to another user or moved to a different location.

## 1.1 Structure of the manual

This manual contains important safety and installation instructions that must be observed during installation and maintenance of the device.

## 1.2 Scope

This product manual describes the installation, electrical connection, commissioning, maintenance and fault elimination procedures of the Hybrid Inverter.

## 1.3 Target group

This manual is intended for specialist electrical engineers who are responsible for the installation and commissioning of the inverter in the PV Storage system, as well as the PV Storage system operators.

## 1.4 Symbols used

This manual contains information on safe operation and uses symbols to ensure the safety of persons and property as well as the efficient operation of the inverter. Please read through the following symbol explanations carefully in order to prevent injury or property damage.

### **DANGER**

Non-observance will result in death or serious injury.

- Follow the warnings in order to prevent death or serious injury!

### **WARNING**

Non-observance will result in death or serious injury.

- Follow the warnings in order to prevent serious injury!

### **CAUTION**

Non-observance may result in minor injury.

- Follow the warnings in order to prevent injury!

### **ATTENTION**

Non-observance may result in property damage!

- Follow the warnings in order to prevent damage to or destruction of the product.

### **NOTE**

- Provides tips essential to the optimal operation of the product.



## 2. BASIC SAFETY INFORMATION

### NOTE

If you have any questions or problems after reading the following information, please contact your installer.

This chapter details the safety information pertaining to the installation and operation of the device.

### 2.1 Safety information

Read and understand the instructions within this manual and familiarize yourself with the relevant safety symbols in this chapter before beginning with the installation of the device and eliminating any faults.

Before connecting to the power grid, you must obtain official authorization from the local power grid operator in accordance with the corresponding national and state requirements. Furthermore, operation may only be carried out by qualified electricians.

Please contact the nearest authorized service center if any maintenance or repairs are required. Please contact your dealer to obtain information about your nearest authorized service center. Do NOT carry out repairs on the device yourself; this may lead to injury or property damage.

Before installing the device or carrying out maintenance on it, you must open the DC switch in order to interrupt the DC voltage of the PV generator. You can also switch off the DC voltage by opening the DC switch in the generation junction box. Not doing this may result in serious injury.

#### 2.1.1 Qualified personnel

Personnel tasked with the operation and maintenance of the device must have the qualifications, competence and experience required to perform the described tasks, while also being capable of fully understanding all instructions contained within the manual. For safety reasons, this inverter may only be installed by a qualified electrician who:

- has received training on occupational safety, as well as the installation and commissioning of electrical systems
- is familiar with the local laws, standards and regulations of the grid operator.

The manufacturer assumes no responsibility for the destruction of property or any injuries to personnel caused by improper usage.

#### 2.1.2 Installation requirements

Please install the inverter according to the information contained in the following section. Mount the inverter to a suitable object with a sufficient load-bearing capacity (e.g. walls, PV frames etc.) and ensure that the inverter is upright. Choose a suitable place for the installation of electrical devices. Ensure that there is sufficient space for an emergency exit which is suitable for maintenance. Ensure sufficient ventilation in order to guarantee an air circulation for the cooling of the inverter.

### 2.1.3 Transport requirements

The factory packaging is specifically designed to prevent transport damage, i.e. violent shocks, moisture and vibrations. However, the device must not be installed if it is visibly damaged. In this case, notify the responsible transport company immediately.

### 2.1.4 Labelling on the device

The labels must NOT be concealed by items and foreign objects (rags, boxes, devices, etc.); they must be regularly cleaned and kept clearly visible at all times.

### 2.1.5 Electrical connection

Observe all applicable electrical regulations when working with the Solar inverter.

#### **DANGER**

##### **Dangerous DC voltage**

- Before establishing the electrical connection, cover the PV modules using opaque material or disconnect the PV generator from the inverter. Solar radiation will cause dangerous voltage to be generated by the PV generator!

##### **Danger through electric shock!**

- All installations and electrical connections may only be carried out by trained electricians!

#### **IMPORTANT**

##### **Authorization for grid feed-in**

- Obtain authorization from the local power grid operator before connecting the inverter to the public power grid.

#### **NOTE**

##### **Voiding of guarantee**

- Do not open the inverter or remove any of the labels. Otherwise, the shall assume no guarantee.

### 2.1.6 Operation

#### **DANGER**

##### **Dangerous voltage!**

- Before carrying out any repair work, first switch off the AC circuit breaker between the inverter and power grid, and then the DC switch.
- After switching off the AC circuit breaker and the DC switch, wait a minimum of 5 minutes before starting any maintenance or repair work.

## Electric shock

- Contact with the electrical grid or the device's terminals may result in an electric shock or fire!
- Do not touch the terminal or the conductor which is connected to the electrical grid.
- Follow all instructions and observe all safety documents that refer to the grid connection.

### CAUTION

#### Burning due to hot housing

- While the inverter is being operated, several internal components will become very hot.
- Please wear protective gloves!
- Keep children away from the device!

#### 2.1.7 Repair and maintenance

### IMPORTANT

#### Unauthorized repairs!

- Following the elimination of any faults, the inverter should be fully functional once more. Should any repairs be required, please contact a local authorized service center.
- The internal components of the inverter must NOT be opened without the relevant authorization.
- The hardware and software after-sale service can be received from the authorized dealer. Software updates service will be available for warranty years from the manufacture date via the OTA(Over-The-Air) download technology. Please contact the authorized dealer in your region for detailed information.

## 2.1 Symbols and signs

### CAUTION

#### Beware of burning hazards due to the hot housing!

- While the inverter is in operation, only touch the display and the buttons, as the housing can become hot.

### ATTENTION

#### Implement Grounding!



- The PV generator must be earthed in accordance with the requirements of the local power grid operator!
- For reasons of personal safety, we recommend that all PV module frames and inverters of the PV system are reliably earthed.

## **⚠ WARNING**

### **Damage due to overvoltage**

- Ensure that the input voltage does not exceed the maximum permissible voltage. Overvoltage may cause long-term damage to the inverter, as well as other damage that is not covered by the warranty!

Several symbols pertaining to safety can be found on the inverter. Please read and understand the content of these symbols before starting the installation.

<b>symbols</b>	<b>Description</b>
	Residual voltage is present in the inverter! Before opening the inverter, you should wait five minutes to ensure that the capacitor has been fully discharged.
	Caution! Danger through electric shock.
	Caution! Hot surface.
	Disconnect the inverter from all the external power sources before maintenance!
	The product is compliant with EU guidelines.
	Do not dispose of the inverter together with household waste.
	Please read the manual before installing the inverter.
	Grounding point.
	Do not remove the DC input connector or AC output connector when the inverter is running.

# 3. PRODUCT OVERVIEW

## 3.1 Product Introduction

The Hybrid Inverter is a three-phase grid-tied PV string inverter with battery interfaces that converts the DC power generated by PV strings into AC power and feeds the power into the power grid. With the integrated energy management function, it can control and optimize the energy flow so as to maximize the self-consumption of PV system.

## 3.2 Appearance

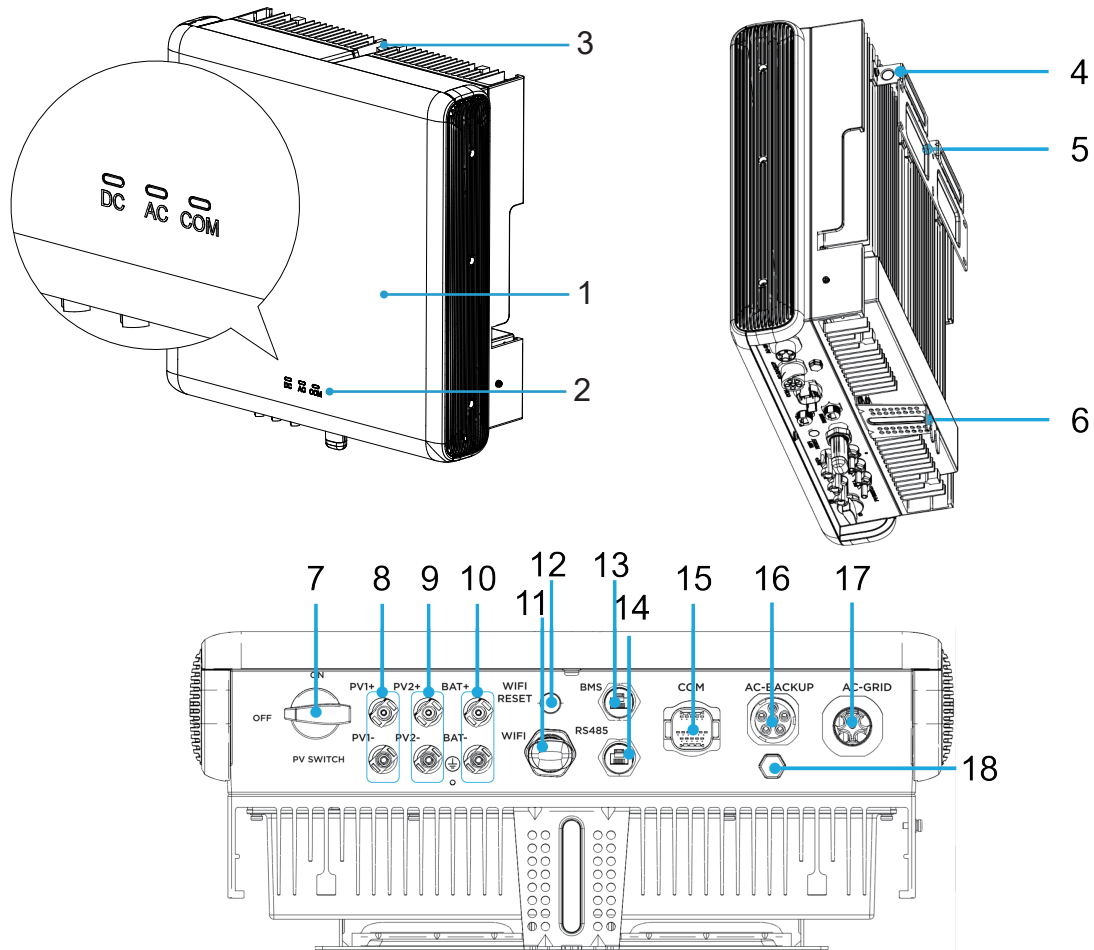

- |    |                              |    |                               |
|----|------------------------------|----|-------------------------------|
| 1  | Front panel                  | 2  | LED indicator                 |
| 3  | Heat sink                    | 4  | Mounting holes                |
| 5  | Mounting bracket             | 6  | Hanging kit                   |
| 7  | PV Switch                    | 8  | PV input terminal(PV1+/PV1-)  |
| 9  | PV input terminal(PV2+/PV2-) | 10 | BAT input terminal(BAT+/BAT-) |
| 11 | Wireless module port         | 12 | Wireless button               |
| 13 | Communications port(BMS)     | 14 | Communications port(RS485)    |
| 15 | Communications port(COM)     | 16 | AC-Backup output port         |
| 17 | AC-Grid output port          | 18 | Ventilation valve             |

## Dimensions

The following figure shows the dimensions of the inverter.

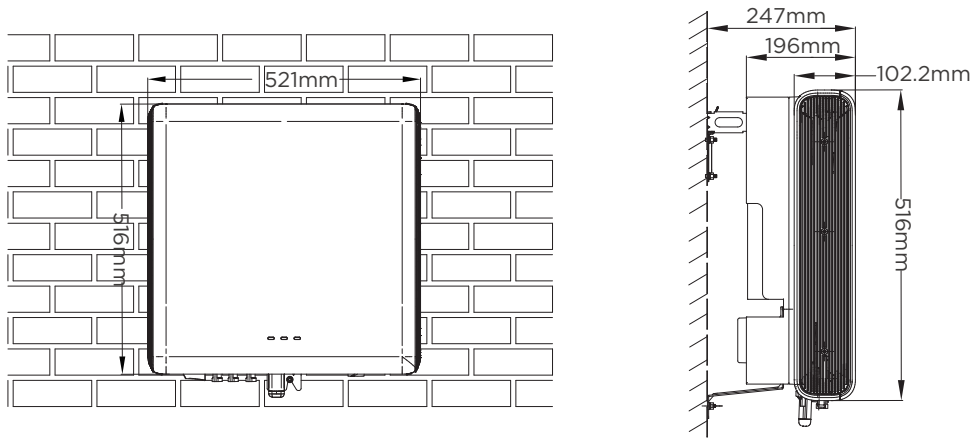

## 3.3 LED indicators

INDICATOR	COLOR	STATUS	EXPLANATION
DC	Green	Steady on	PV power available
	Yellow	Steady on	PV power not available/ too low
	Red	Steady on	Fault
	-	Off	System is power-off
A C	Green	Steady on	Inverter is operating
	Green	Blinking at long intervals (on for 1s and then off for 1s)	Inverter in standby in grid-tied mode
	Yellow	Steady on	Inverter is operating in off-grid mode
	Yellow	Blinking at long intervals (on for 1s and then off for 1s)	Inverter in standby in off-grid mode
	Red	Steady on	Fault
	-	Off	System is power-off
COM	Green	Blinking at long intervals (on for 0.2s and then off for 0.2s)	Wireless waiting for connection
	Green	Blinking at long intervals (on for 1s and then off for 1s)	Establishing wireless connection
	Green	Steady on	Wireless connected
	Yellow	Steady on	Bluetooth connected
	-	Off	No wireless/bluetooth connected

## 3.4 PV System

### 3.4.1 Introduction

The Hybrid Inverter can be used as PV grid-connected inverters.

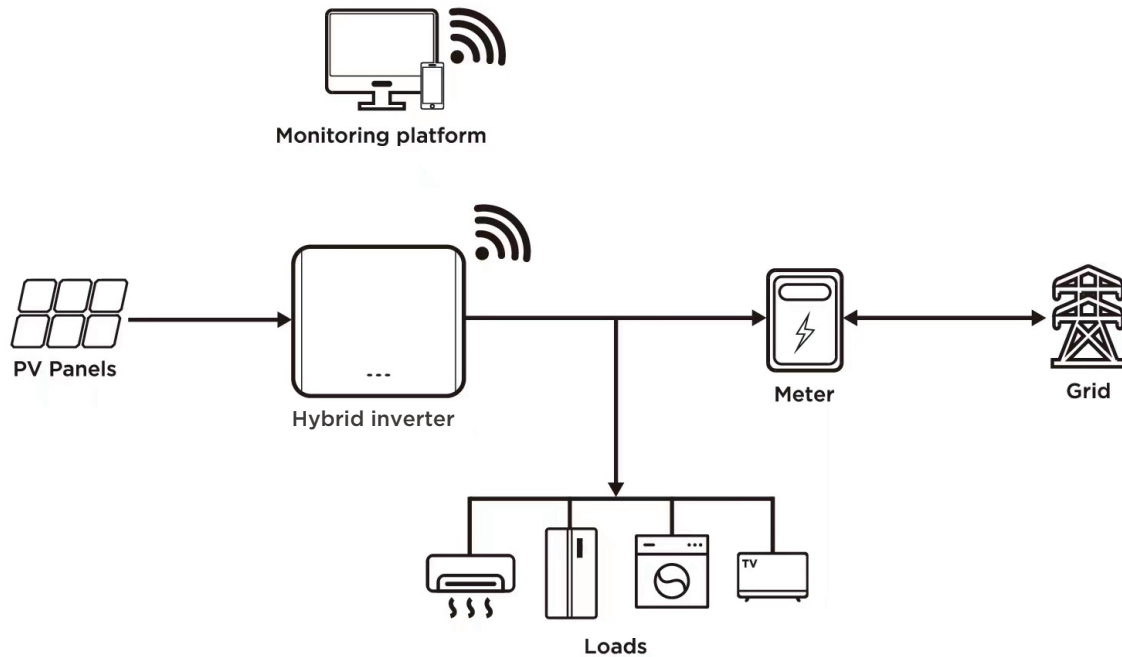

### ATTENTION

- Please be sure that the potential voltage between N and PE line is not higher than 30V, otherwise, inverter will stop generating power.
- The system cannot be used to supply emergency power through backup port.

### 3.4.2 Working mode

The Hybrid Inverter can work in standby, operating, or shutdown mode.

Working mode	Description
Standby	<p>The Hybrid Inverter enters Standby mode when the external environment does not meet the operating requirements. In Standby mode:</p> <ul style="list-style-type: none"> <li>• The Hybrid Inverter continuously performs status check and enters the Operating mode once the operating requirements are met.</li> <li>• The Hybrid Inverter enters Shutdown mode after detecting a shutdown command or a fault after startup.</li> </ul>
Operating	<p>In Operating mode:</p> <ul style="list-style-type: none"> <li>• The Hybrid Inverter converts DC power from PV strings into AC power and feeds the power to the power grid.</li> <li>• The Hybrid Inverter tracks the maximum power point to maximize the PV string output.</li> <li>• If Hybrid Inverter detects a fault or a shutdown command, it enters the Shutdown mode.</li> <li>• The Hybrid Inverter enters Standby mode after detecting that the PVstring output power is not suitable for connecting to the power grid for generating power.</li> </ul>

Working mode	Description
Shutdown	<ul style="list-style-type: none"> <li>• In Standby or Operating mode, the Hybrid Inverter enters Shutdown mode after detecting a fault or shutdown command.</li> <li>• In Shutdown mode, the Hybrid Inverter enters Standby mode after detecting a startup command or that the fault is rectified.</li> </ul>

### 3.5 PV Energy Storage System

#### 3.5.1 Introduction

By directly connecting a battery module to the inverter, the conventional PV system can be upgraded to be an PV Energy Storage System( PV ESS). The system is capable of operating off-grid to ensure an emergency power supply for protected loads in the event of a grid interruption or blackout, which may be caused by:

- islanding;
- under-voltage;
- under-frequency or over-frequency.

#### ATTENTION

- Under any connection, either grid-connection or off-grid application, please be sure that the potential voltage between N and PE line is not higher than 30V, otherwise, inverter will stop generating power.
- The system is not suitable for supplying life-sustaining medical devices. It cannot guarantee backup power in all circumstances. The PV generator must be earthed in accordance with the requirements of the local power grid operator!

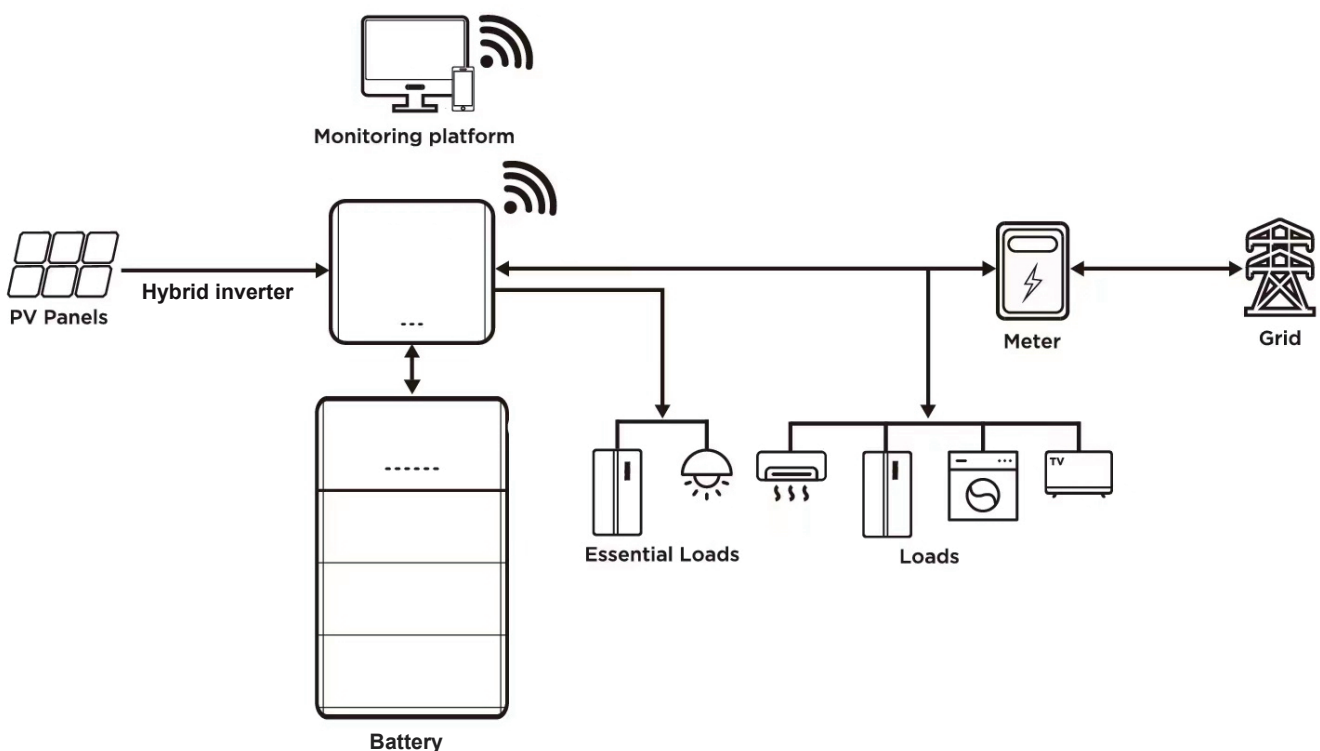



### 3.5.2 Declaration for Back-Up Function

The following statement involves general policies about the inverters described in this document.

1 For hybrid inverters, the electrical installation typically includes connection of the inverter to both PV modules and batteries. If there is no available power from batteries or PV modules in backup mode, the backup power supply will be automatically terminated. The inverters shall hold no liability for any consequences arising from failing to observe this instruction.

2 Normally, the Back-Up switching time is less than 3 s. However, some external factors may cause the system to fail on Back-Up mode. Therefore, the users must be aware of conditions and follow the instructions as below:

- Do not connect loads that are dependent on a stable energy supply for a reliable operation.
- Do not connect the loads whose total capacity is greater than the maximum Back-Up capacity.
- Do not connect the loads that may cause very high start-up current surges, such as nonfrequency conversion air conditioning, vacuum cleaner or half-wave loads such as hair dryer, heat gun, hammer drill. Refer to 3.5.3 "The Compatibility for Backup under Off-grid Scenario" for recommended loads.
- Due to the condition of the battery itself, battery current might be limited by some factors, including but not limited to the temperature and weather.
- BACK-UP is not recommended if the PV system is not configured with batteries. Otherwise, the risk in system power usage is beyond the equipment manufacturer's warranty scope.
- When single overload protection occurs, the inverter can restart automatically; however, the restarting time will be extended if it happens several times.
- When the grid is disconnected, the off-grid function of the inverter will be closed automatically if the load capacity exceeds the inverter's rated power; to enable it, turn off the large loads and ensure the load power is less than the rated power of the inverter.

### Declaration for Back-Up Overload Protection

The inverter will restart in case of overload protection. The time required for restarting will increase (5 min at most) if overload protection repeats. Try to reduce Back-Up load power within maximum limitation or remove the loads which may cause very high start-up current surges.

### 3.5.3 The Compatibility for Backup under Off-grid Scenario

The information below is about the compatibility for backup of Hybrid Inverter with energy storage unit under off-grid scenario. Please refer to this information before you use the back-up function of the inverter under off-grid situation.

#### Recommended backup loads

Type	Load Power
Dust collector	1.3kW
Water heater/Kettle /Iron /Oven /Toaster /Geothermal blanket / Rice cooker	3 kW
Microwave oven	1.5kW
Refrigerator	1kW
TV / Computer	1Kw
Bath heater	2.5kW
Fluorescent / LED lights	1.3kW
Electric fan / Ceiling fan	2kW
Conditioner(frequency conversionmodulation)	1.5P

## NOTE

- The data of the compatibility for backup of Hybrid Inverter are based on the test with batteries (-20 ~ 55 °C, 5~100% SOC). For the actual application, please refer to the maximum output capacity of the battery used.

For those loads that not covered in this document, please contact your installer to make sure the compatibility of the specific loads under off-grid scenario. The manufacturer will not be held responsible for the usage of any load without confirmation. We will keep updating this document, please contact the manufacturer if there are any relevant issues.

### **3.5.4 Working modes**

The battery discharges to provide energy to loads. If the battery is empty or there is not enough power from the battery system, the grid shall supply power to backup loads and normal loads.

When the grid is present, the bypass function of the Hybrid Inverter is activated and the Backup loads will be directly connected to the grid via the bypass switch integrated in the inverter.

If the smart meter is abnormal or not equipped, the inverter will run normally, however, the battery can be charged but not allowed to discharge. In this case the feed-in limitation setting will be ineffective.

#### **Mode1: Maximize Self-consumption**

This mode is suitable for areas with high electricity tariff. When the PV power is sufficient, priority is given to the local load, and the excess electricity goes to energy storage, and if there is still energy left, it is sold to the grid. When the PV power is insufficient/there is no PV power, the battery is discharged for the local load, and when the battery discharge power and photovoltaic power can not meet the load demand, the insufficient power will be purchased from the grid.

#### **Mode2: Maximize Feed-in**

This mode is suitable for areas with high feed-in tariff. When the PV power is greater than the inverter capacity, the excess electricity will be stored by energy storage. When PV power is less than the inverter capacity, the excess electricity will be sold to the grid.

#### **Mode3: Backup power**

This mode is suitable for areas where grid outages occur frequently or to prevent grid outages. Reserved Backup SOC setting value can be adjusted, when battery SOC is less than reserved SOC value, battery can only be charged, until SOC reaches reserved value, the battery will be stopped charging; when SOC is larger than SOC setting value, battery will behave as Self-use mode.

#### **Mode4: Charge and discharge schedule**

This mode is suitable for areas with peaks and valleys in electricity prices Battery charging period and discharging period can be set, during charging period, battery can only be charged, while in discharging period, battery can only be discharged, the rest of the period, battery will behave as Self-use mode.

# 4. FUNCTION DESCRIPTION

## 4.1 Protection

Several protective functions are integrated in the inverter, including short circuit protection, grounding insulation resistance surveillance, residual current protection, anti-islanding protection, DC overvoltage / over-current protection, etc.

## 4.2 Energy Conversion and Management

The inverter converts the DC power from the PV array or the battery to the AC power, in conformity with the grid requirements. It also transmits the DC power from the PV panel to the battery. With the bidirectional converter integrated inside, the inverter can charge or discharge the battery. Multiple string MPP trackers are used to maximize the power from PV strings with different orientations, tilts, or module structures.

### 4.2.1 Power Deration

Power deration is a way to protect the inverter from overload or potential faults. In addition, the deration function can also be activated following the requirements of the utility grid. Situations requiring inverter power deration are:

- over-temperature (including ambient temperature and module temperature)
- high input voltage
- grid under-voltage
- grid over-frequency
- power factor (when values out of the rated values)
- high altitude

### 4.2.2 Regular Operational Voltage Range

The inverters can operate within the allowable voltage range for at least the specified observation time. The setting of the conditions depends on whether the connection is due to a normal operational start-up or an automatic reconnection after tripping of the interface protection. When the voltage level is out of the operational levels, the inverter will disconnect from the grid within the protection time. If a disturbance lasts less than the required protection time, the inverter can reconnect to the grid once the voltage level goes back to normal levels after the disturbance.

### 4.2.3 Regular Operational Frequency Range

The inverter can operate within its frequency range for at least the specified observation time. The setting of conditions depends on whether the connection is due to a normal operational start-up or an automatic reconnection after tripping of the interface protection. When the frequency level is outside the operational levels, the inverter will disconnect from the grid. If a disturbance lasts less than the required protection time, the inverter can reconnect to the grid once the frequency level goes back to normal levels after the disturbance.

### 4.2.4 Reactive Power Regulation

The inverter is capable of operating in reactive power regulation modes for the purpose of providing support to the grid. The reactive power regulation mode can be set via the App.

### 4.2.5 Load Control

The inverter has an integrated multiple-function dry-contact (DO relay), which can be used for load control via a contactor.

### 4.3 Battery Management

The maximum allowable charge/discharge current is limited to the smaller value among the following:

- Temperature;
- the maximum power of inverter;
- the maximum / recommended charge/discharge current from the battery manufacturer.

For this reason, the battery charge power may not reach the nominal power.

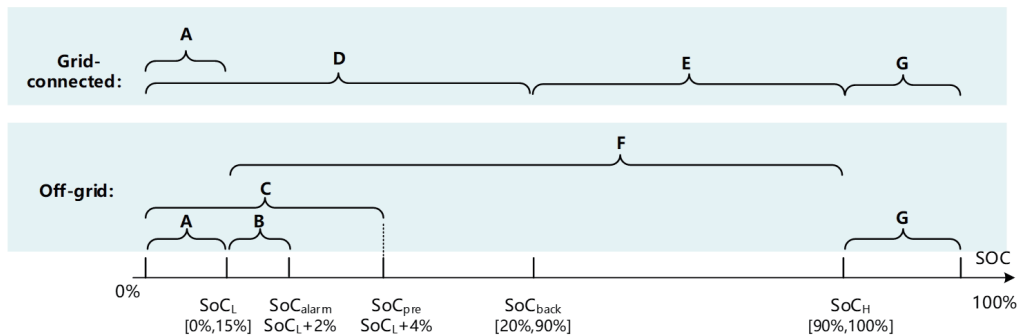

The inverter cannot respond to discharge/charge command when operating off-grid.

Range	Battery management behavior
A	In this range, the battery is no longer discharged, even in battery-backup operation. $SoC_L$ can be set from 0 to 15% in APP. See 8.4 APP commissioning.
B	When operating off grid, the system reports the low SoC state.
C	When starting up in off -grid condition, the system does not output AC power, so as to charge the battery by all PV power.
D	When operating grid-connected, the system charges / discharges the battery for PV power economy. $SoC_{back}$ can be set from 20 to 90% in APP. See 8.4 APP commissioning.
E	When operating grid-connected, the system charges / discharges the battery for PV power economy.
F	When operating off -grid, the system charges / discharges the battery to support the system and obtain PV power economy.
G	The battery can be discharged to support the system or for PV power economy, while it cannot be charged. The inverter cannot respond to charge command in this range. $SoC_H$ can be set from 90 to 100% in APP. See 8.4 APP commissioning.

#### 4.4 Feed-in limitation function

The function of the feed-in limitation is to control the amount of power injected in the grid by the plant. In some situations, this function is also called as Export limitation or Zero export. The feed-in limitation function requires a power measurement device must be installed.

Feed-in limitation: The sum of the feeding-in phases must not exceed the set power limitation value. The power of phases drawing power from the grid is disregarded here.

3-phase limit: The sum of the feed-in power of all three phases must not exceed the set power limit value. This setting is suitable for balancing metering.

#### NOTE

For the 3-phase limit setting, the current sensors must be correctly assigned to phases L1, L2 and L3 on the electricity meter!

#### 4.5 Charge-from-grid limitation function

The function of the Charge-from-grid limitation is to limit the amount of power charging the battery from the grid. The Charge-from-grid limitation function requires a power measurement device must be installed according to system A, B, or C.

Charge-from-grid limitation: The sum of the Charge-from-grid phases must not exceed the set power limitation value. The power of phases drawing power from the grid is disregarded here.

3-phase limit: The sum of the Charge-from-grid power of all three phases must not exceed the set power limit value. This setting is suitable for balancing metering.

#### NOTE

For the 3-phase limit setting, the current sensors must be correctly assigned to phases L1, L2 and L3 on the electricity meter!

# 5. STORAGE

The following requirements should be met if the M1 series inverter is not put into use directly:

- Do not unpack the M1 series inverter.
- Keep the storage temperature at  $-40^{\circ}\text{C}$  to  $+70^{\circ}\text{C}$  and the humidity at 5%– 95% RH.
- The M1 series inverter should be stored in a clean and dry place and be protected from dust and water vapor corrosion.
- A maximum of eight M1 series inverter can be stacked. To avoid personal injury or device damage, stack M1 series inverter with caution to prevent them from falling over.
- Periodic inspections are required during the storage. Replace the packing materials if necessary.
- If the M1 series inverter has been long-term stored, inspections and tests should be conducted by qualified personnel before it is put into use.

# 6. INSTALLATION

## 6.1 Installation information

### DANGER

#### Fire hazard

- Do not install the inverter on flammable material.
- Do not install the inverter in an area in which flammable or explosive material is stored.

### CAUTION

#### Burning hazard

- Do NOT install the inverter in places where it can be accidentally touched. The housing and heat sink may become very hot while the inverter is being operated.

### IMPORTANT

#### Weight of the device

- Take into account the weight of the inverter when transporting and moving it.
- Choose a suitable installation location and surface.
- Commission a minimum of two persons for the installation of the inverter.
- Do not set down the inverter overhead.





## 6.2 Examination before installation

### 6.2.1 Checking the external packaging materials



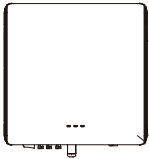
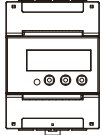
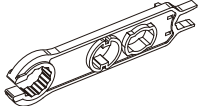
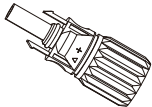

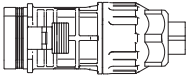
Packaging materials and components may become damaged during transportation. Therefore, the external packaging materials must be examined before the inverter is installed. Check the external packaging material for damage, e.g. holes and cracks. If you discover any damage, do not unpack the inverter and contact the transport company and/or dealer immediately. It is recommended that the packaging material should be removed within 24 hours before installing the inverter.

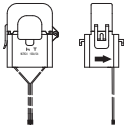
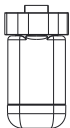
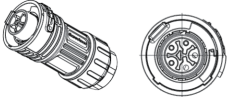
### 6.2.2 Checking the delivery scope



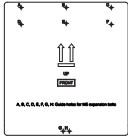
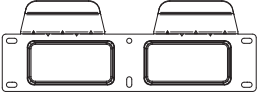

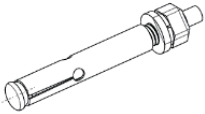
After unpacking the inverter, check that the delivery items are both intact and complete. In the event of any damage or missing components, contact the wholesaler.



No.	Pictures	Description	Quantity
01		Hybrid inverter	1
02		Smart meter	1
03		D4 Disassembly tool	1
04		Photovoltaic connector - Straight female	2
05		Photovoltaic connector - Straight male	2
06		Communication connector	1
07		BACK-UP AC connector	1
08		PE terminal	2
09		Current transformer	3
10		Wireless module	1
11		ON-GRID AC connector	1

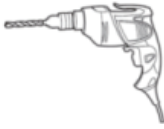

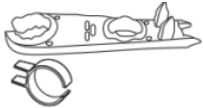
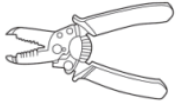
No.	Pictures	Description	Quantity
12		Marking-off template	1
13		Mounting bracket	1
14		Smart meter RS485 cable	1
15		Expansion bolt	8
16		Quick guide	1
17		Packing list	1
18		User manual	1
19		Delivery inspection report	1
20		Quality certificate	1
21		Warranty card	1

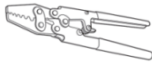
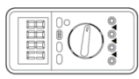
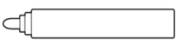
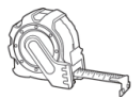
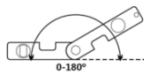
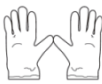
## 6.3 Tools

No.	Tool	Model	Function
01		Hammer drill Recommended drill diameter: 8mm	Used to drill holes in the wall
02		Screwdriver	Wiring
03		Phillips screwdriver	Used to remove and install the screws of the AC termina
04		Removal tool	Used to remove the PV battery terminal
05		Wire stripper	Used to strip the wire
06		6mm Allen key	Used to turn the screw to connect the rear panel to the inverter
07		Crimping tool	Used to crimp power cables
08		Multimeter	Used to check the Grounding
09		Marker	Used for marking
10		Measuring tape	Used to measure distances
11		Spirit level	Used to align the wall bracket
12		ESD gloves	For the installer

No.	Tool	Model	Function
13		Safety goggles	For the installer
14		Anti-dust respiratory mask	For the installer

## 6.4 Installation Requirement

### 6.4.1 Environment Requirements

#### Basic requirements

- The Hybrid Inverter is protected to IP65 and can be installed indoors or outdoors.
- Do not install the Hybrid Inverter in a place where personnel are easy to come into contact with its enclosure and heat sinks, because these parts are extremely hot during operation.
- Do not install the Hybrid Inverter in areas with flammable or explosive materials.
- Do not install the Hybrid Inverter at a place within children's reach.
- Do not install the Hybrid Inverter outdoors in salt areas because it will be corroded there and may cause fire. A salt area refers to the region within 500 meters from the coast or prone to sea breeze. The regions prone to sea breeze vary depending on weather conditions (such as typhoons and monsoons) or terrains (such as dams and hills).
- The Hybrid Inverter must be installed in a well-ventilated environment to ensure good heat dissipation.
- Recommended: Install the Hybrid Inverter in a sheltered place or a place with an awning.

#### Mounting requirements

The mounting structure where the Hybrid Inverter is installed must be fireproof.

- Do not install the Hybrid Inverter on flammable building materials.
- The Hybrid Inverter is heavy. Ensure that the installation surface is solid enough to bear the weight load.
- In residential areas, do not install the Hybrid Inverter on drywalls or walls made of similar materials which have a weak sound insulation performance because the noise generated by the Hybrid Inverter is noticeable.

## 6.4.2 Space Requirements

### Angle Requirements

The inverter can be wall-mounted or pole-mounted. The installation angle requirements are as follows:

- Install the inverter vertically or at a maximum back tilt of 15 degrees to facilitate heat dissipation.
- Do not install the inverter at forward tilted, excessive back tilted, side tilted, horizontal, or upside down positions.

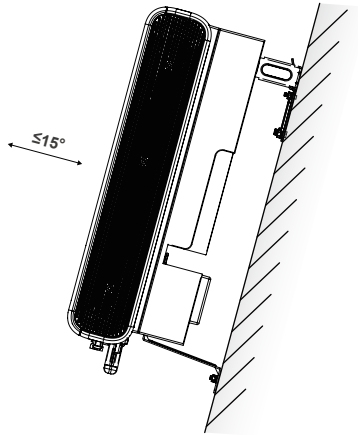

### Space Requirements

Reserve enough space around the inverter to ensure sufficient space for installation and heat dissipation.

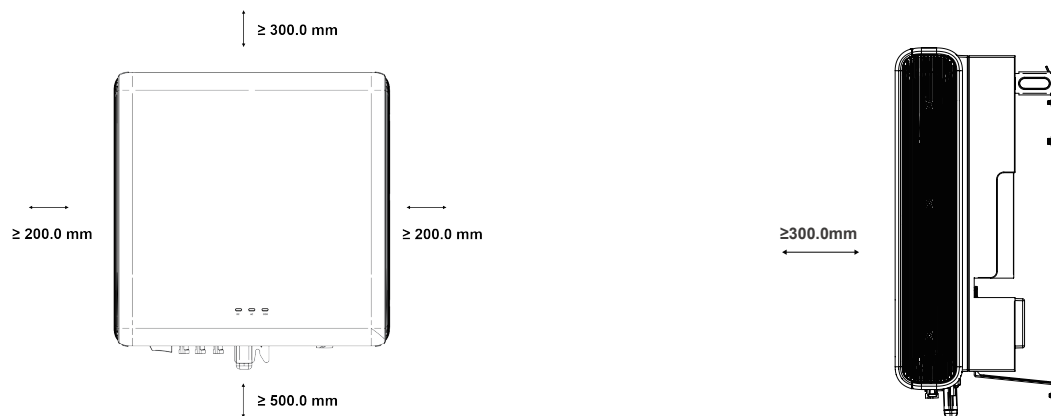

## 6.5 Unpacking the inverter

Open the packaging and grip underneath the inverter at the sides with both hands.

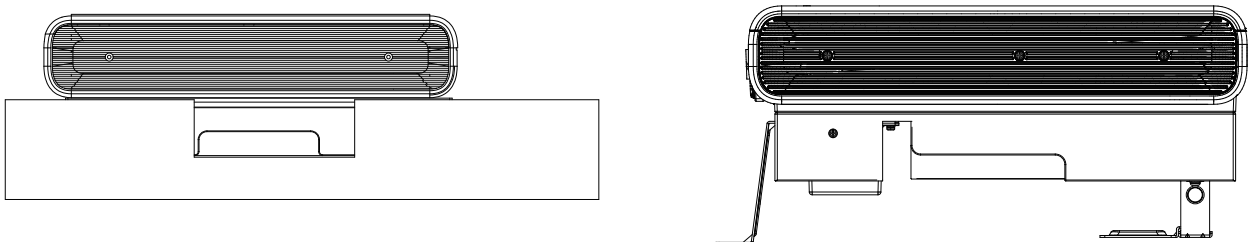

Lift the inverter out of the packaging and move it to its installation position.

## ATTENTION

### Mechanical damage

- In order to prevent injuries and damage to the device, ensure that the inverter is kept balanced while it is being moved - it is very heavy.
- Do not place the inverter on its connections, as these are not designed to bear its weight. Place the inverter horizontally on the ground.
- When you place the inverter on the ground, place foamed material or paper underneath it in order to protect its housing.

### 6.6 Installation procedure

Step1. Determine the positions for drilling holes and mark the positions using a marker.

Step2. Drilling 6 holes in the wall and place the expansion tubes and Install the mounting bracket.

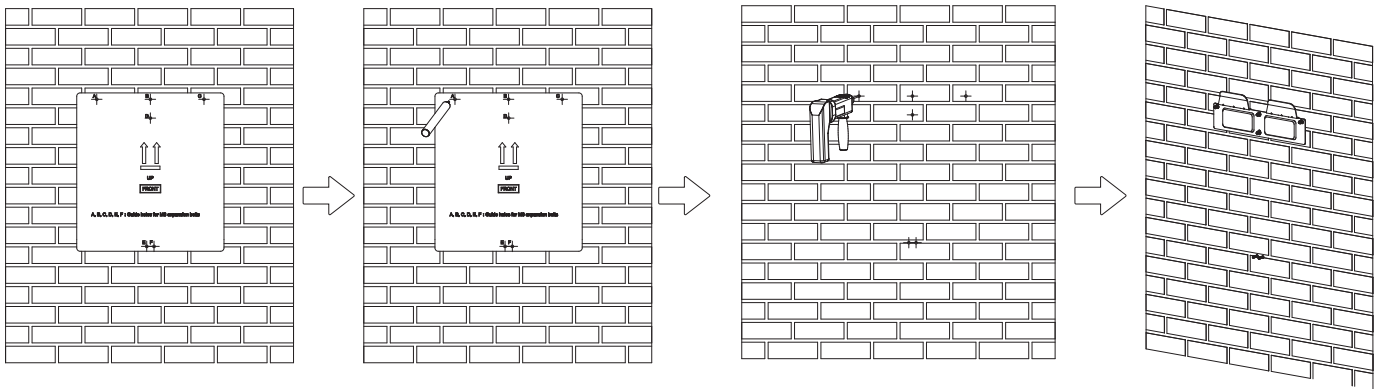

Step3. Mount the Inverter into the mounting bracket.

Step4. Tighten the nut.

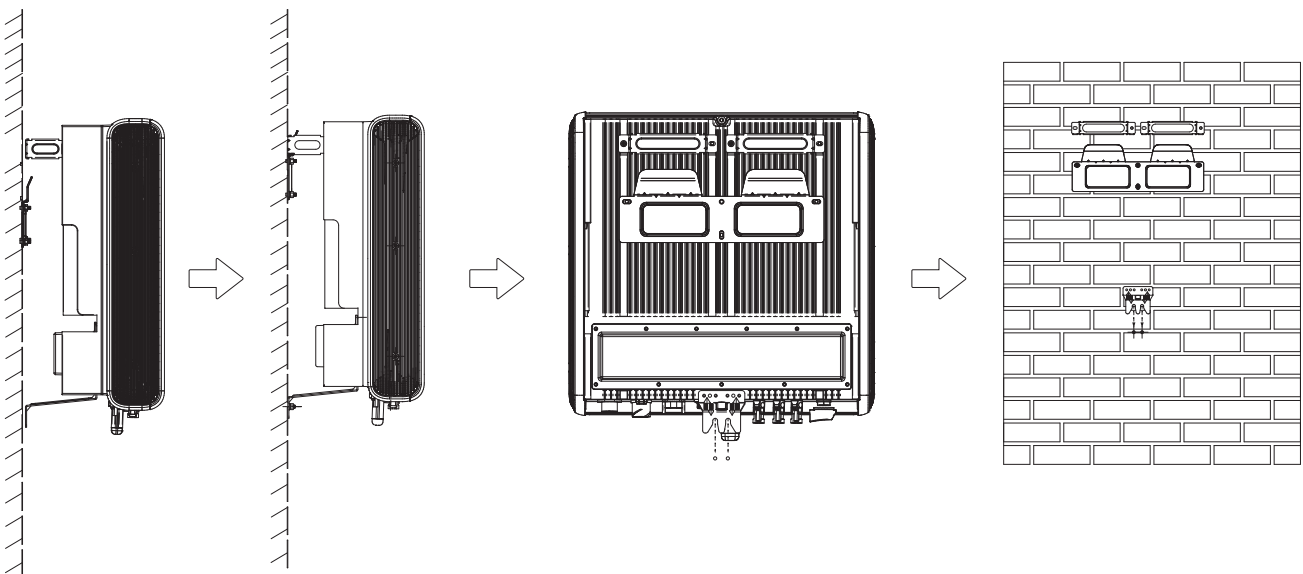

# 7. ELECTRICAL CONNECTION

## 7.1 Safety instructions

This topic describes the electrical connections of the inverter. Read this section thoroughly and carefully before connecting the cables.

### DANGER

#### Electrical voltage at the DC connections.

- Ensure that the DC switch is OFF before establishing the electrical connection. The reason is that the electrical charge remains in the capacitor after the DC switch has been switched off. Therefore, at least 5 minutes must lapse before the capacitor has been electrically discharged.

### DANGER

#### Electrical voltage.

- PV modules generate electrical energy when exposed to sunlight, and this may present an electrical shock hazard. Therefore, cover the PV modules with an opaque sheet before connecting to the DC input power cable.

### DANGER

#### Electrical voltage at the DC connections.

- Wear rubber gloves and protective clothing (safety goggles and boots) when working on high voltage/high current systems such as inverter and battery systems.

### ATTENTION

#### Qualification

- The installation and maintenance of the inverter must be carried out by an electrician.

### NOTE

- The open-circuit voltage of the modules connected in series must be lower than or equal to 1000 V.

The connected PV modules must be compliant with IEC 61730 class A.

Device	Isc PV (absolute maximum)	Maximum output overvoltage protection
Hybrid Inverter	16 A/16 A	14 A*3

The DVC (decisive voltage classification) is the circuit voltage which constantly occurs between two arbitrary live parts during proper use in a worst-case scenario:

Description of limits for DVC

DVC	Operating voltage limit (V)		
	AC voltage (RMS)	AC voltage(PK)	DC voltage (AVG)
A	25(16)	35.4(22.6)	60(35)
B	50(33)	71(46.7)	120(70)
C	1000	4500	1500

Note: The values in brackets apply when the inverter is installed in a humid environment.

The decisive voltage class (DVC)

Interface	DVC
PV input connection	DVCC
AC connection	DVCC
Battery connection	DVCC
Load connection	DVCC
USB/WiFi interface	DVCA
COM interface	DVCA
CT interface	DVCA
DRMs	DVCA
Link port	DVCA

## 7.2 Electrical Diagram

There are different system configurations possible depending on the user's requirements, existing electrical infrastructure and local regulations. The distribution box must be configured to comply to the grid operator requirements. The inverter has an integrated AC relay to disconnect all phases and Neutral from the grid in case of grid fault or grid outage.

The inverter's generation and feed-in limitation functions require the use of an external measurement device to obtain grid information.

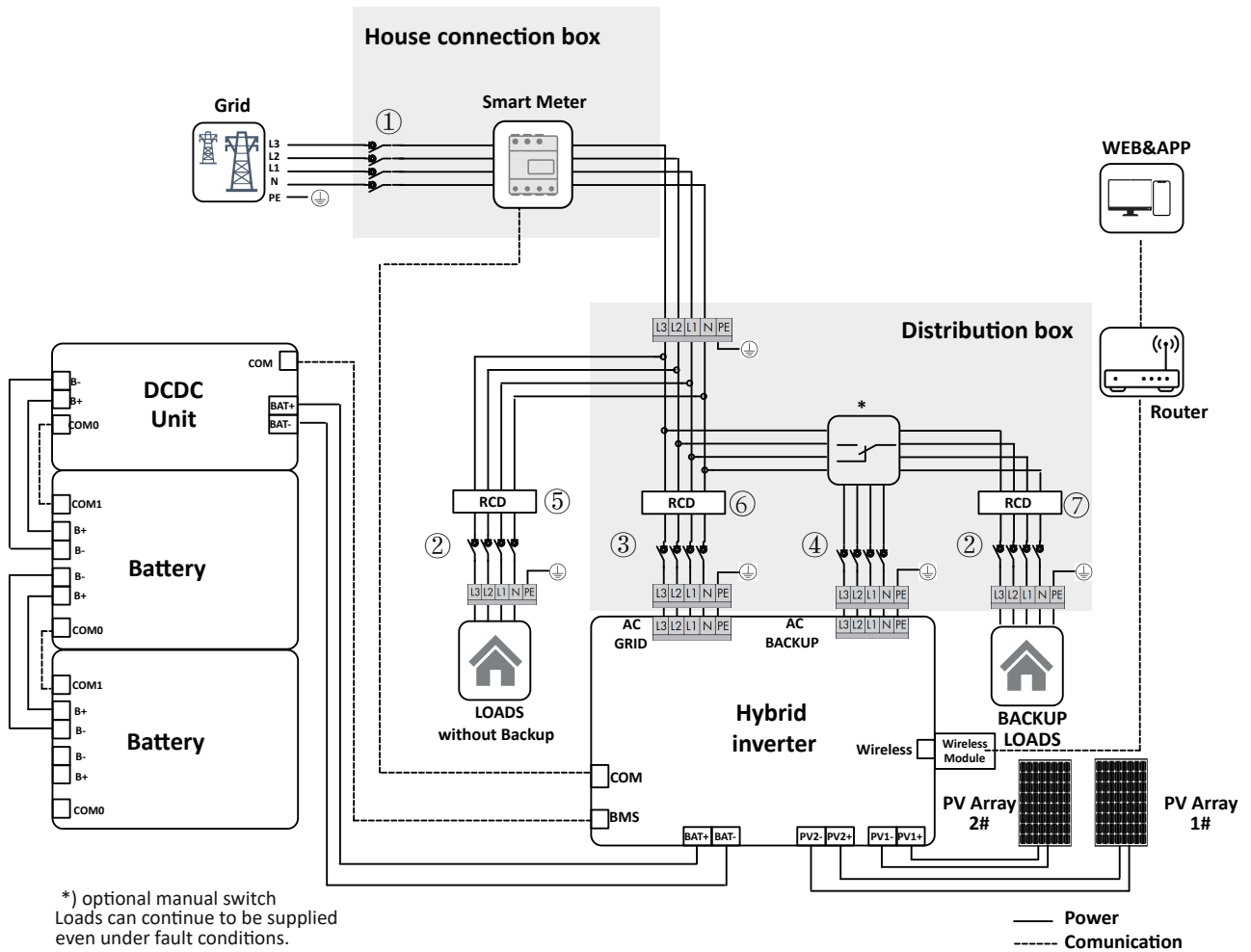

1	Depends on household loads and inverter capacity
2	D depends on loads
3	32A/400V AC breaker
4	25A/400V AC breaker
5	30mA RCD
6	300mA RCD
7	30mA RCD

## NOTE

- The values in the table are recommended values and can be set to other values according to actual conditions.

## 7.3 Ground Connection

Connect the inverter to the equipotential bonding bar by using the protective earth cable (PE) for grounding.

## ATTENTION

### Pole Grounding not permissible!

- As the inverter is transformerless, the plus and minus poles of the PV generator must NOT be earthed. Otherwise, the inverter will malfunction. In the PV system, not all live metal parts (e.g. PV module frames, PV frame, generator connection box housing, inverter housing) require Grounding.



1.Remove the insulation of the cable. For outside use, cables of  $\geq 4\text{mm}^2$  are recommended for Grounding).

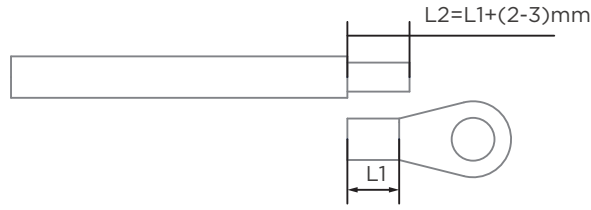

2.Crimp the cable to the ring terminal:

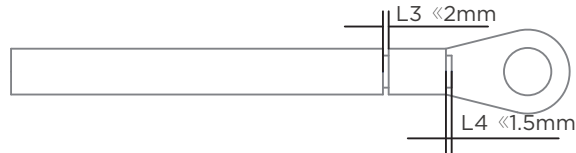

3.Install the crimped ring terminal and the washer with M4 screws and tighten these with a torque of 1.5 Nm using an Allen key:

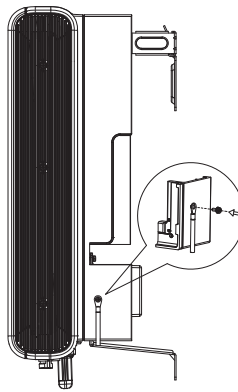

## 7.4 AC Output Connection

The AC power cables are used to connect the inverter to the critical loads (through the AC-BACKUP port), and the AC power distributor or the power grid.

### **⚠ CAUTION**

#### **AC connection**

- Each inverter must have its own circuit breaker.
- The AC disconnecting device must be easily accessible.

#### **Electrical voltage**

- Ensure that the grid has been switched off before removing the AC connector.

Please follow below steps to install the AC connector.

- 1) Select the suitable cable in accordance with above diagram. Remove the insulating layer of the AC output cable using a wire stripper and in accordance with the following illustration.

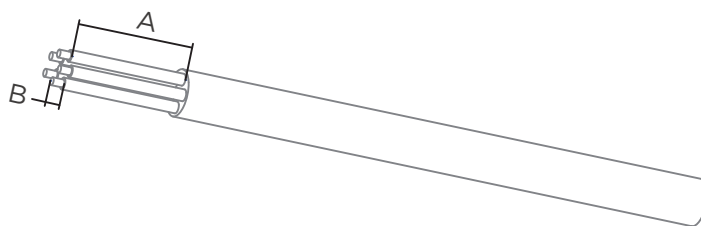

A = 30~50 mm  
B = 3~5 mm

- 2) Disassemble the connector in accordance with the following illustration. Guide the AC output cable through the cable gland.

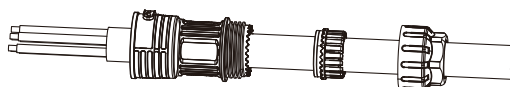

- 3) Connect the AC cable in accordance with the following requirements and tighten the terminal using the Allen key.

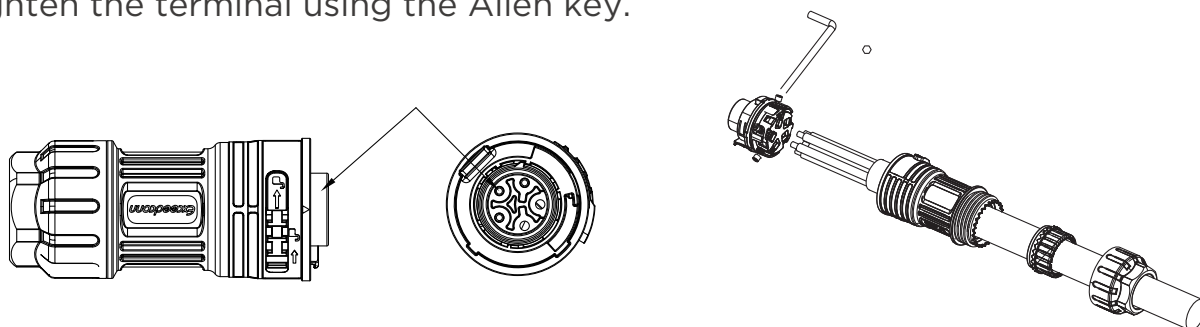

Connection	Cable
L1	Phase 1 (brown)
L2	Phase 2 (black)
L3	Phase 3 (grey)
N	Neutral conductor (blue)
PE	Grounding cable (yellow-green)

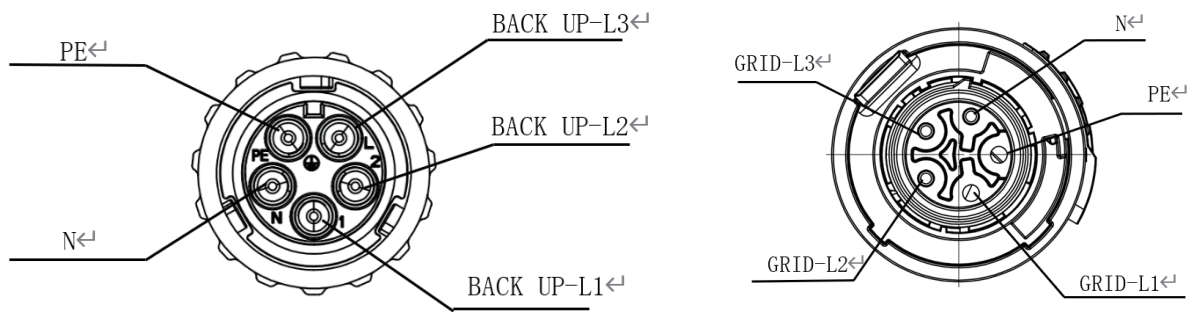

- 4) Assemble the connector housing and screw the cable gland tight.
- 5) Connect the AC connector to the AC connector of the inverter by turning it clockwise until it locks into place.

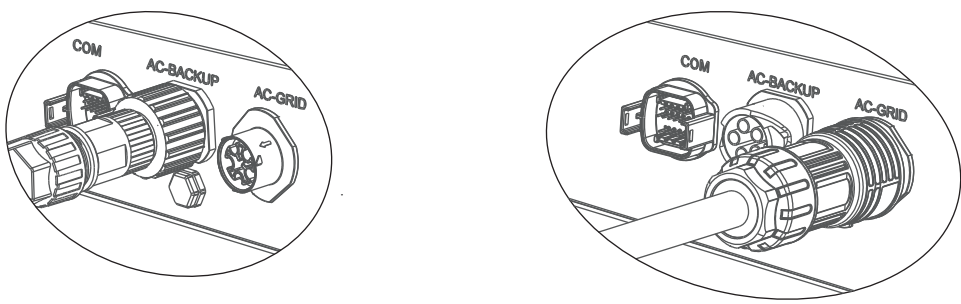

**NOTE**

- Remove the AC connector by turning it anticlockwise.
- When you use the meter connection function, make sure that the AC terminal cable corresponds to the meter cable one by one( L1, L2, L3, N, and PE cables).

**7.5 DC connection**

**NOTE**

- The connection steps of the battery and PV are the same, only the terminal specifications are different. The colour of the battery terminal is blue, the colour of PV terminal is black.

Please observe the recommended cable dimensions:

Cable cross-section (mm <sup>2</sup> )		Outer diameter of cable (mm)
Range	Recommended value	
4.0 - 6.0	4.0	4.5 - 7.8

1. Remove the crimp contacts from the positive and negative connections.
2. Remove the insulation of the cables:

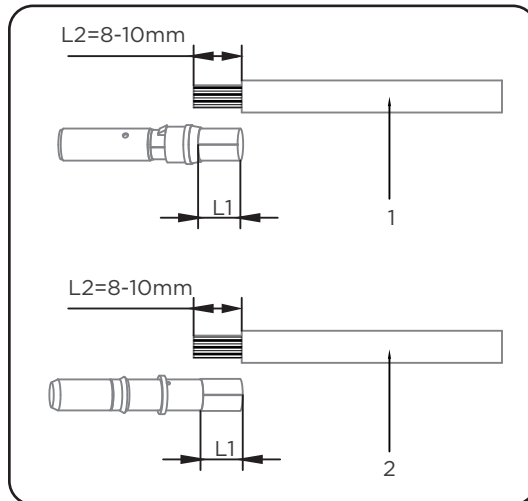

Note: L2 is 2 to 3mm longer than L1

- ① Positive DC cable      ② Negative DC cable

3. Insert the positive and negative DC cables into the corresponding cable glands.
4. Crimp the DC cables. The crimped cable must be able to withstand a tractive force of 400 Nm.

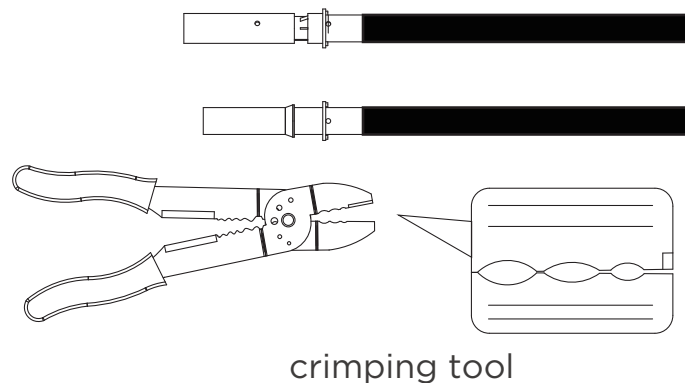

crimping tool

### ⚠ CAUTION

#### Danger of reverse polarity!

- Ensure that the polarity is correct before plugging into the DC connections!

5. Insert the crimped DC cables into the corresponding connector housing until you hear a “clicking” sound.

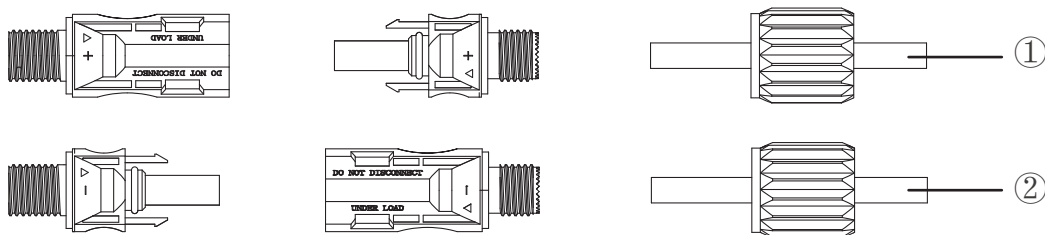

- ① Positive power cable      ② Negative power cable

6. Re-screw the cable glands to the connector housing.

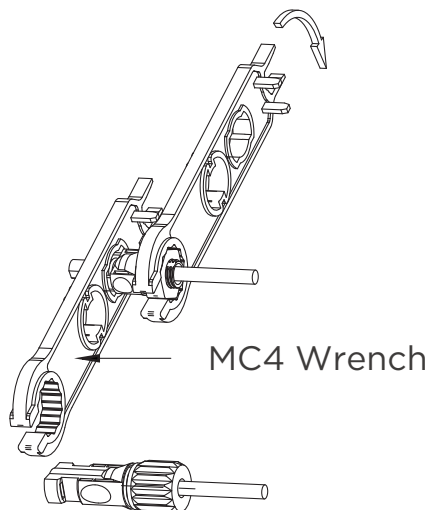

7. Insert the positive and negative connectors into the corresponding DC input terminals of the inverter until you hear a “clicking” sound.

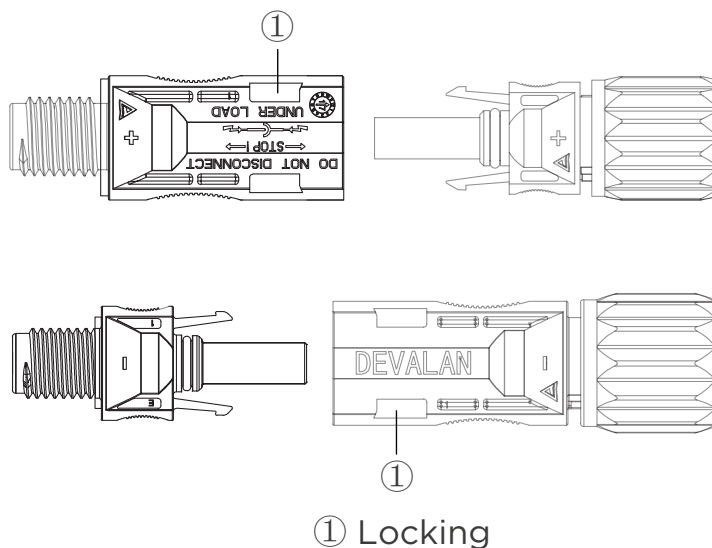

### NOTE

- Insert the protective caps into the unused DC connections. Removing the connectors.

### CAUTION

#### Danger of DC arcing

- Before removing the plus and minus connector, ensure that the DC switch has been set to OFF.

In order to remove the plus and minus connection from the inverter, insert a removal key into the locking and press on the key with the adequate force as shown in the following illustration:

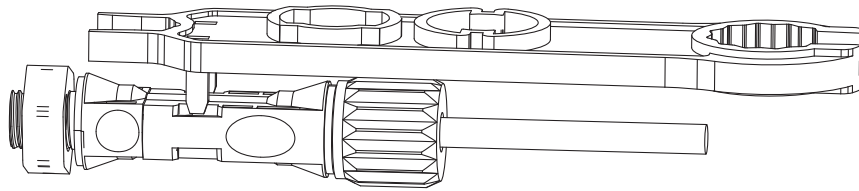

## 7.6 Smart Meter Connection

The integrated energy management functions integrated of the inverter require to measure the power flow at the point of grid interconnection.

Please refer to below table for the PIN assignments for the RS485 connection between the inverter and the energy meter.

Inverter COM Port Pin	Function	Meter Pin
Pin 8	RS485+ (A2)	Pin 24
Pin 9	RS485- (B2)	Pin 25

### NOTE

- Use the shielded twisted pair cable.
- The copper outer diameter should be more than 0.5 mm<sup>2</sup>.
- Keep away from power cables or other electric fields.
- Maximum distance is 1200 meters.

## Energy Meter through CTs:

Technical Data	
Voltage	AC 3×230/400 V
Current	0.05-1.5 (6) A
Frequency	50/60 Hz
Pulse	6400 Imp / kWh

# Energy meter with CT connection

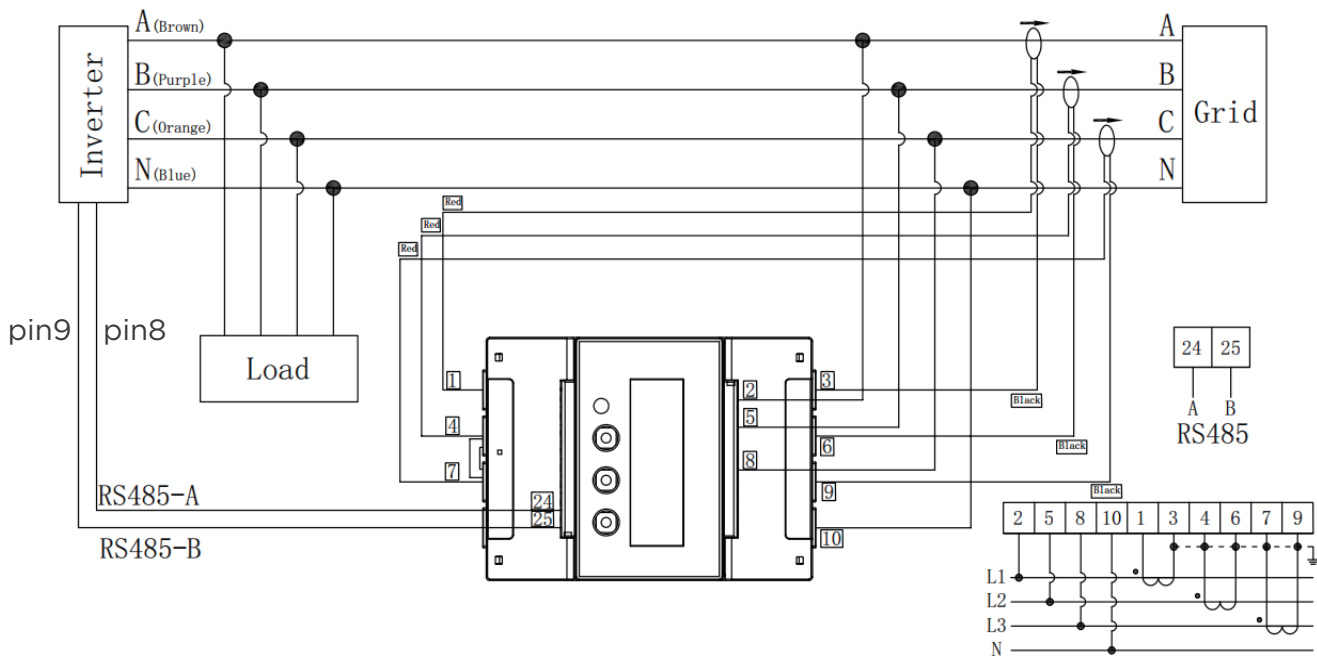
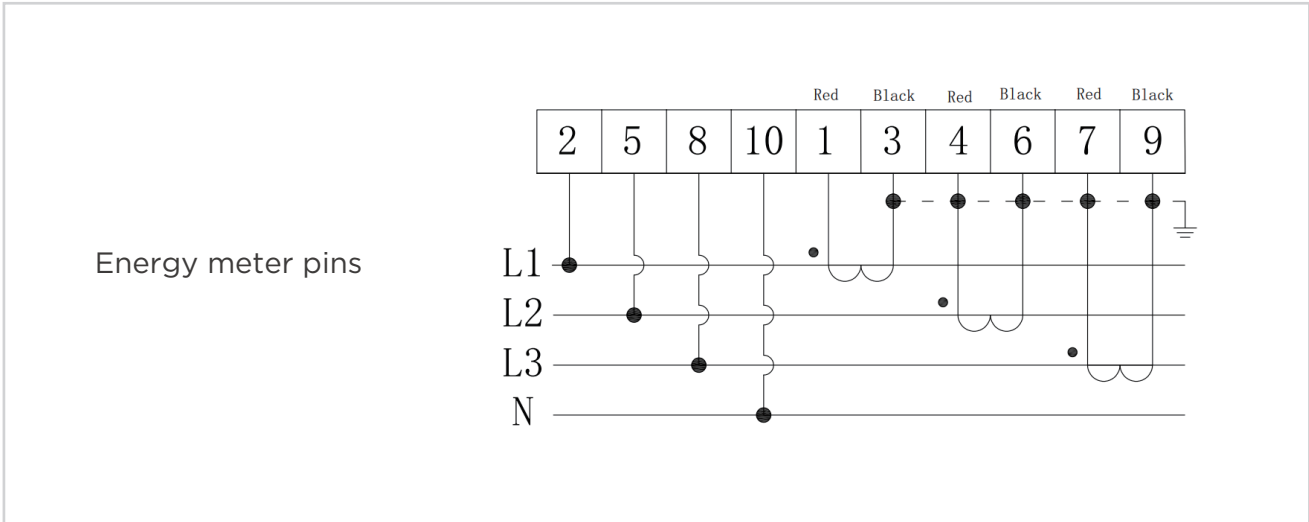

## NOTE

- The arrows on the current transformers direct to the grid.
- Up to 100 A measurement
- Accuracy class and load rating(VA/Ω):0.5 class
- Rated operating voltage:AC 0.66KV(Equivalent to 0.69KV GB156-2003)
- Rated frequency: 50-60Hz
- Ambient temperature: -40℃~85℃
- Altitude: ≤3000m

P1 → P2 Grid

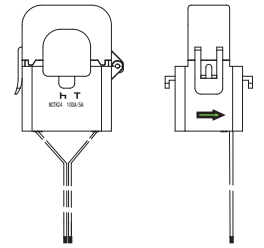

## Energy meter with CT connection

The energy meter is preconfigured to be used with the inverter with these settings:

Modbus Address: 3

Baud Rate: 9600

Current Ratio: 20:1

In case you want to change or check the settings, please refer to below procedure:

## Modbus Address and Baud Rate setting

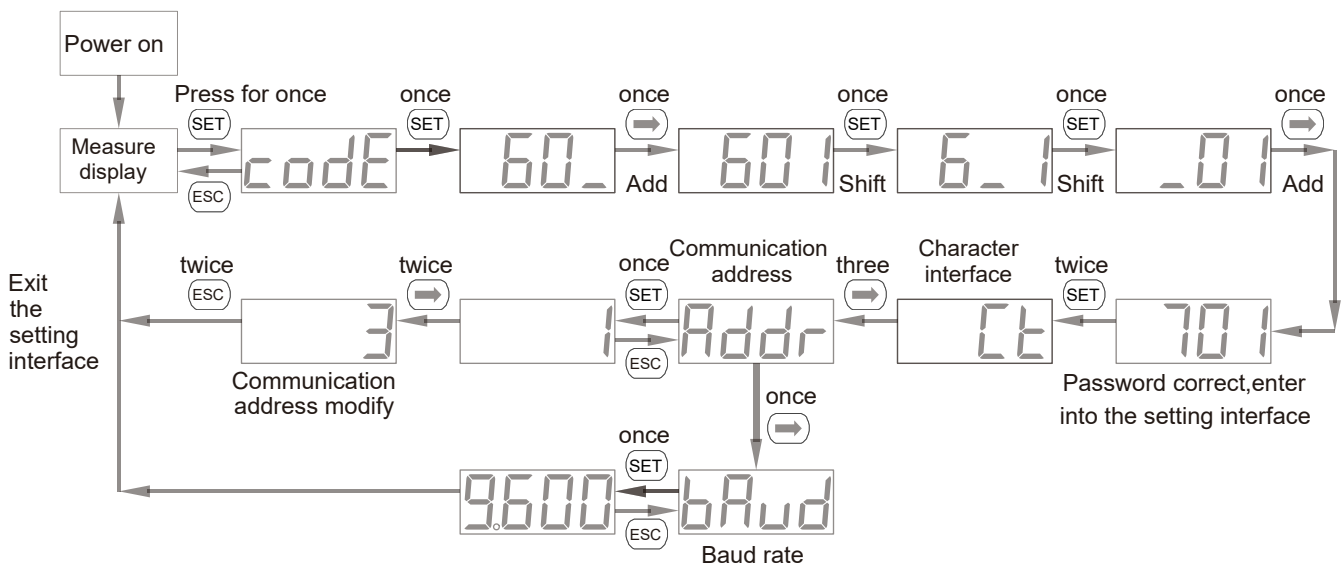

## Current Ratio setting

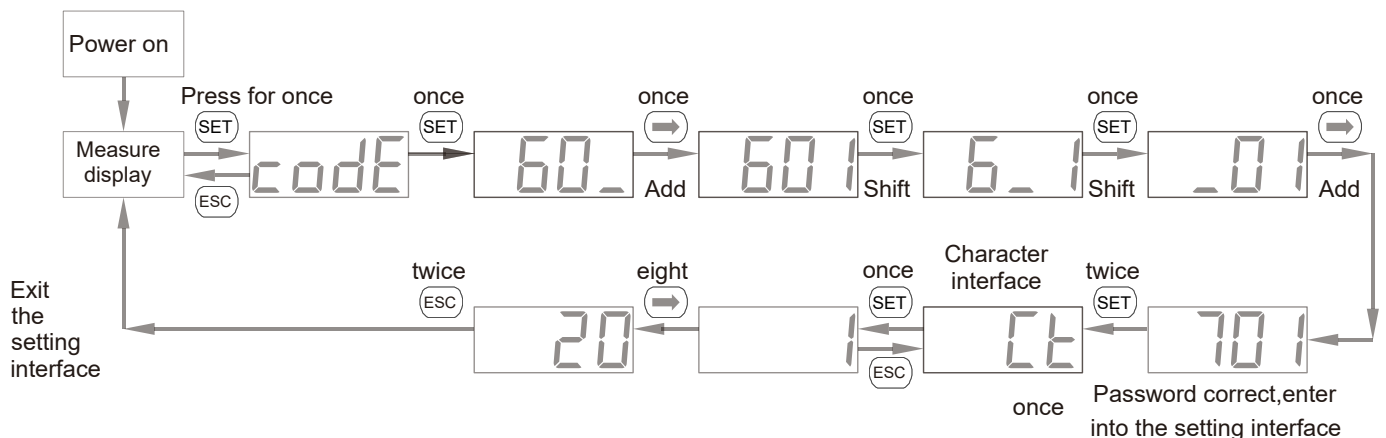



**NOTE**

- The inverter connected to the meter is a power generation device, and the function of the meter connected to the traditional load (electrical device) is opposite. Therefore, for our product, when the power is output to the grid, the electricity meter will show a positive value, and when the power is purchased from the grid, it will show a negative value;
- The energy meter comes with 2 terminal resistors, In the actual configuration, the customer can parallel a terminal resistor at each end of the cable to reduce signal reflection in the communication cable.

**7.7 Wireless Module Connection**

**Procedure:**

1. Remove the protective cap from the USB interface.
2. Install the Wireless stick.
3. Tighten the connecting nut.

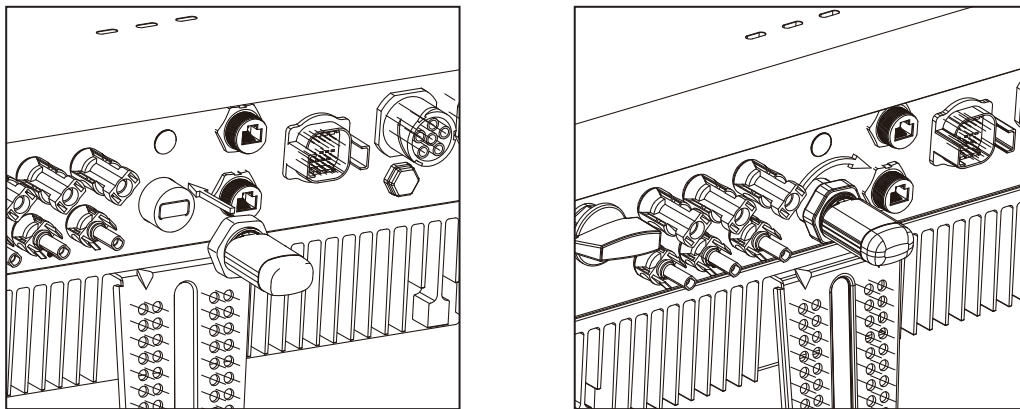

**7.8 Communication Connection**

Please refer to the following table for the specific PIN assignments.

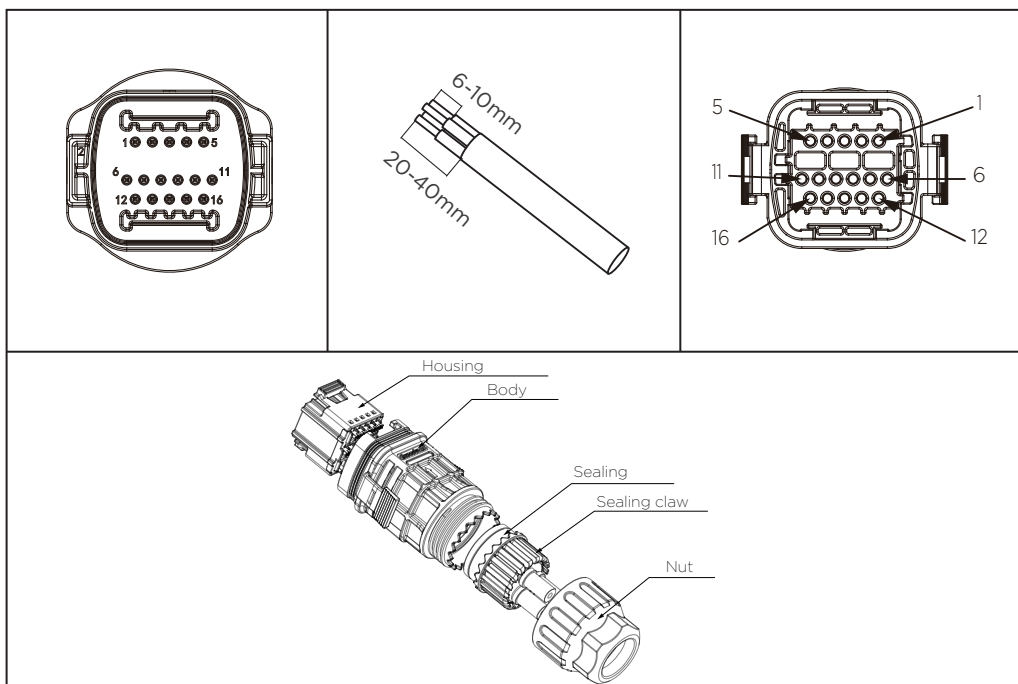

PIN	Definition	Function
1	DO1-	Dry contacts of load control
2	N/A	N/A
3	DO1+	Dry contacts of load control
4-7	N/A	N/A
8	RS485A1	Communicate with smart meters
9	RS485B1	
10	RS485A2	Communicate with heat pump
11	RS485B2	
12	RS485A3	Communicate with EMS
13	RS485B3	
14	DI1	Remote shutdown signal
15	N/A	N/A
16	COM	12V power supply

### Installing the cable

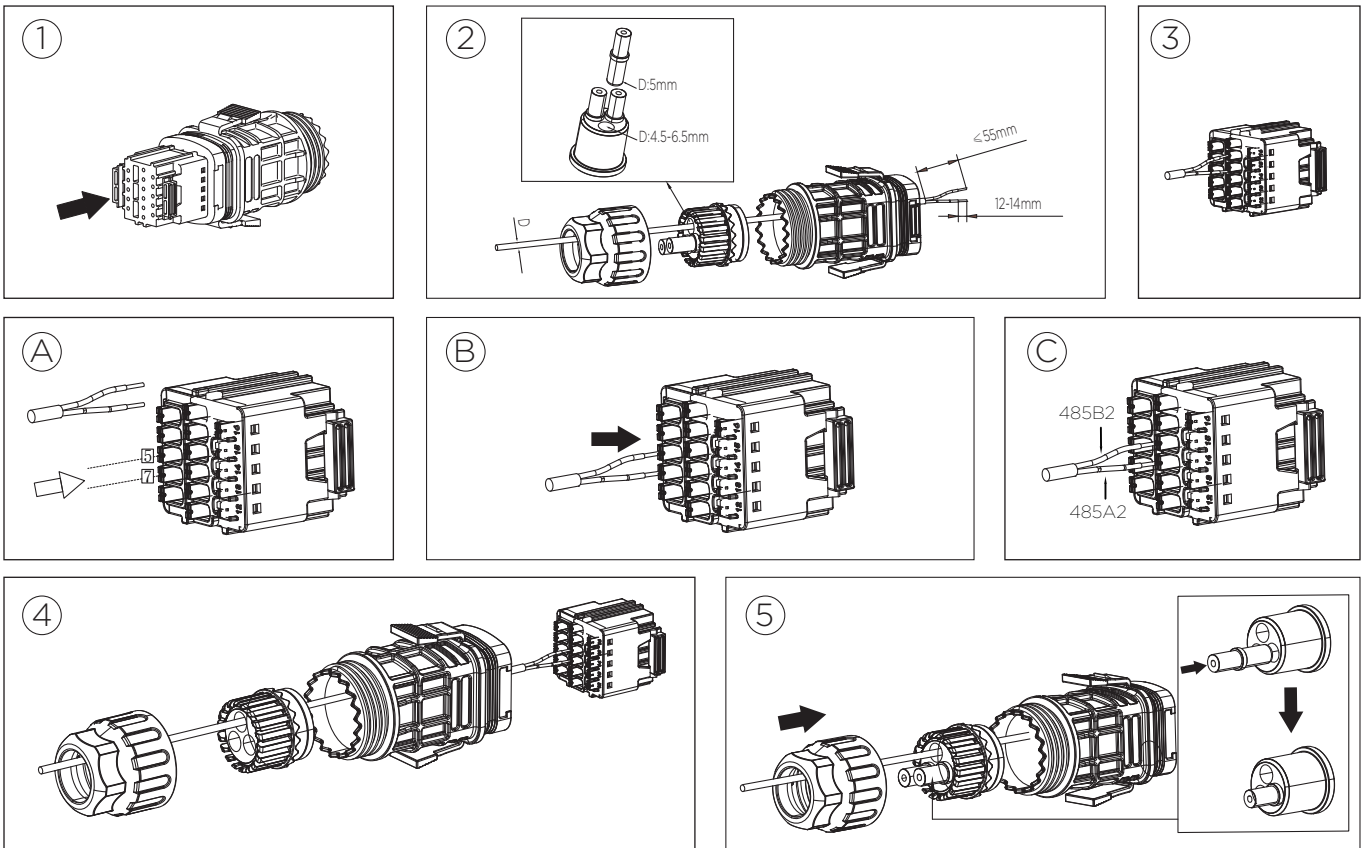

### Connect the signal cable to the COM port.

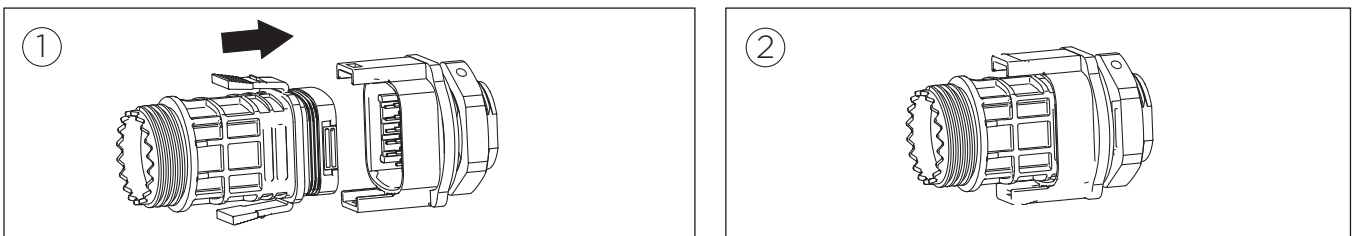

# 8. COMMISSIONING

## 8.1 Safety test before commissioning

### ATTENTION

#### Check the voltage range

- Ensure that the DC and AC voltages are within the permissible range of the inverter.

## 8.2 Check before power-on

No.	Item	Acceptance Criterion
1	Inverter installation	The Inverter is installed correctly and securely.
2	Battery installation (optional)	The Energy Storage Unit is installed correctly and securely.
3	Wireless module	The Wireless module is installed correctly and securely.
4	Cable routing	The cables are routed properly as required by the customer.
5	Cable ties	Cable ties are secured evenly and no burr exists.
6	Reliable grounding	The PE cable is connected correctly and securely.
7	Switch	DC switches and all the switches connecting to the Inverter are OFF.
8	Cable connection	The AC output power cable, DC input power cables, battery cable, and signal cable are connected correctly and securely
9	Unused terminals and ports	Unused terminals and ports are locked by watertight caps.
10	Installation environment	The installation space is proper, and the installation environment is clean and tidy.

### 8.3 System power-on

1. If a battery is connected, turn on the battery switch.
2. Turn on the AC switch between the inverter and the power grid.
3. Turn on the DC switch (if any) between the PV string and the inverter.
4. Turn on the DC switch at the bottom of the inverter.
5. Wait for about 1 minute and observe the LED indicators on the inverter to check its running status.

INDICATOR	COLOR	STATUS	EXPLANATION
DC	Green	Steady on	PV power available
	Yellow	Steady on	PV power not available/ too low
	Red	Steady on	Fault
	-	Off	System is power-off
AC	Green	Steady on	Inverter is operating
	Green	Blinking at long intervals (on for 1s and then off for 1s)	Inverter in standby in grid-tied mode
	Yellow	Steady on	Inverter is operating in off-grid mode
	Yellow	Blinking at long intervals (on for 1s and then off for 1s)	Inverter in standby in off-grid mode
	Red	Steady on	Fault
	-	Off	System is power-off
COM	Green	Blinking at long intervals (on for 0.2s and then off for 0.2s)	Wireless waiting for connection
	Green	Blinking at long intervals (on for 1s and then off for 1s)	Establishing wireless connection
	Green	Steady on	Wireless connected
	Yellow	Steady on	Bluetooth connected
	-	Off	No wireless/bluetooth connected

## 8.4 APP commissioning

Download and install the app. Search goMsolar and MSmartHome in the Apple or Google Play store, or use the following QR codes:

- MSmartHome (for end users):



- goMsolar (for installers):



### NOTE

Please refer to the App user manual for detailed operations. Scan the QR code to download the APP user manual.



# 9.MAINTENANCE

## 9.1 System power-off

If the inverter needs to be shut down for electrical inspection, please follow the following steps:

1. Turn off the AC switch between the inverter and the power grid.
2. Turn off the DC switch at the bottom of the inverter.
3. If there is a DC switch between the inverter and PV string, turn off the DC switch.
4. Turn off the DC switch at the battery(Optional).
5. Wait for 5 minutes before checking the inverter.

### NOTE

- The alarm information can be viewed on the monitoring portal and retrieved via the smartphone app.

## 9.2 Routine Maintenance

Inverters do not generally require daily or routine maintenance. Before carrying out cleaning, ensure that the DC switch and AC circuit breaker between the inverter and power grid have been switched off. Wait at least 5 minutes before carrying out cleaning.

### 9.2.1 Cleaning the inverter

Clean the inverter using an air blower and a dry, soft cloth or a soft bristle brush. Do NOT clean the inverter with water, corrosive chemicals, cleaning agents etc.

### 9.2.2 Cleaning the heat sink

In order to help guarantee correct long-term operation of the inverter, make sure that there is sufficient space for ventilation around the heat sink. Check the heat sink for blockages (dust, snow etc.) and remove them if present. Please clean the heat sink using an air blower and a dry, soft cloth or a soft bristle brush. Do not clean the heat sink with water, corrosive chemicals, cleaning agents etc.

## 9.3 Troubleshooting

This section contains information and procedures pertaining to the remedying of potential problems with the inverter.

To carry out troubleshooting, proceed as follows:

- Check the warnings, error messages or error codes displayed on the screen of the app.

If no error information is displayed on the screen, check whether the following requirements have been fulfilled:

- Has the inverter been set up in a clean, dry, well-ventilated area?
- Is the DC switch set to ON?
- Are the cables sufficiently dimensioned and short enough?
- Are the input connections, output connections and the wiring all in good condition?
- Are the configuration settings for the relevant installation correct?
- Are the the communication cables correctly connected and undamaged?

### 9.3.1 Earth fault alarm

This inverter is compliant with IEC 62109-2 Clause 13.9 for earth fault protection. If an earth fault alarm occurs, the error is displayed on the LED indicators, the red light illuminate.

### 9.3.2 Error list

This section describes the potential errors for this product. Please read carefully for the following tips when doing the troubleshooting:

Alarm severities are defined as follows

**Major:** The inverter is faulty. As a result, the output power decreases or the grid-tied power generation is stopped.

**Minor:** Some components are faulty without affecting the grid-tied power generation.

**Warning:** The inverter works properly. The output power decreases or some authorization functions fail due to external factors.

Alarm ID	Alarm Name	Alarm Severity	Possible Cause	Trouble shooting
1001	String reverse connection	Major	The PV string polarity is reversed.	Check whether the PV string is reversely connected to the inverter. If so, wait until the PV string current decreases to below 0.5 A. Then, turn off the DC switch and correct the PV string polarity.
1002	Abnormal residual current	Major	The input-to-ground insulation impedance has decreased during the inverter operation.	<ol style="list-style-type: none"> <li>1. If the alarm occurs accidentally, the external power cable may be abnormal temporarily. The inverter automatically recovers after the fault is rectified.</li> <li>2. If the alarm persists or lasts a long time, check whether the impedance between the PV string and ground is too low.</li> </ol>
1003	Low insulation resistance	Major	<ol style="list-style-type: none"> <li>1. A short circuit exists between the PV array and the ground.</li> <li>2. The PV array is in a moist environment and the circuit is not well.</li> </ol>	<ol style="list-style-type: none"> <li>1. Check the impedance between the PV array output and the ground. If a short circuit occurs or the insulation is insufficient, rectify the fault.</li> <li>2. Check whether the PE cable of the inverter is correctly connected.</li> <li>3. If you have confirmed that the impedance is lower than the specified protection threshold in a cloudy or rainy environment, log in to WEB and APP set the Insulation resistance protection threshold.</li> </ol>
1004	Cabinet over temperature	Major	<ol style="list-style-type: none"> <li>1. The inverter is installed in a place with poor ventilation.</li> <li>2. The ambient temperature exceeds the upper threshold.</li> <li>3. The inverter is not operating properly.</li> </ol>	<ol style="list-style-type: none"> <li>1. Check the ventilation and ambient temperature at the inverter installation position.</li> <li>2. If the ventilation is poor or the ambient temperature exceeds the upper threshold, improve the ventilation and heat dissipation.</li> <li>3. If the ventilation and ambient temperature are normal, contact your dealer or technical support.</li> </ol>

Alarm ID	Alarm Name	Alarm Severity	Possible Cause	Trouble shooting
1005	Grid loss	Major	1. Power grid outage occurs. 2.The AC circuit is disconnected or the AC switch is off.	1. The alarm is cleared automatically after the power grid recovers. 2. Check whether the AC circuit is disconnected or the AC switch is off.
1006	Power Module Communication failure	Major	The battery communication is abnormal	Check that the communications cable is correctly installed, and that the communication sparameters are the same as the inverter RS485 configurations.
1007	BMS Communication failure	Major	The battery communication is abnormal	Check that the communications cable is correctly installed, and that the communications parameters are the same as the inverter RS485 configurations.
1008	Meter Communication failure	Major	The meter communication is abnormal	Check that the communications cable is correctly installed, and that the communication sparameters are the same as the inverter RS485 configurations.
1009	Equipment fault	Major	An unrecoverable fault occurs on a circuit inside the inverter.	Turn off the AC output switch and DC input switch, and then turn them on after 5 minutes. If the alarm persists, replace the monitoring board or contact your dealer or technical support.
1010	Grid overvoltage	Minor	The grid voltage exceeds the upper threshold or the high voltage duration has lasted for more than the value specified by high voltage ride-through (HVRT).	1. If the alarm occurs occasionally, the power grid may be abnormal temporarily. The inverter automatically recovers after detecting that the power grid becomes normal. 2. If the alarm persists, check whether the power grid voltage is within the acceptable range. If not, contact the local power operator. If yes, modify the grid overvoltage protection threshold through the WEB and APP with the consent of the local power operator. 3. Check whether the peak voltage of the power grid is too high. If the alarm persists and cannot be rectified for a long time, contact the power operator.
1011	Grid undervoltage	Minor	The grid voltage is below the lower threshold or the low-voltage duration has lasted for more than the value specified by low voltage ride-through (LVRT).	1. If the alarm occurs occasionally, the power grid may be abnormal temporarily. The inverter automatically recovers after detecting that the power grid becomes normal. 2. If the alarm persists, check whether the power grid voltage is within the acceptable range. If not, contact the local power operator. If yes, modify the grid overvoltage protection threshold through the WEB and APP with the consent of the local power operator. 3. Check whether the peak voltage of the power grid is too high. If the alarm persists and cannot be rectified for a long time, contact the power operator.



Alarm ID	Alarm Name	Alarm Severity	Possible Cause	Trouble shooting
1012	Grid over frequency	Minor	Power grid exception: The actual power grid frequency is higher than the requirements for the local power grid code.	<ol style="list-style-type: none"> <li>1. If the alarm occurs occasionally, the power grid may be abnormal temporarily. The inverter automatically recovers after detecting that the power grid becomes normal.</li> <li>2. If the alarm persists, check whether the power grid voltage is within the acceptable range. If not, contact the local power operator. If yes, modify the grid overvoltage protection threshold through the WEB and APP with the consent of the local power operator.</li> <li>3. Check whether the peak voltage of the power grid is too high. If the alarm persists and cannot be rectified for a long time, contact the power operator.</li> </ol>
1013	Grid under frequency	Minor	Power grid exception: The actual power grid frequency is lower than the requirements for the local power grid code.	<ol style="list-style-type: none"> <li>1. If the alarm occurs occasionally, the power grid may be abnormal temporarily. The inverter automatically recovers after detecting that the power grid becomes normal.</li> <li>2. If the alarm persists, check whether the power grid voltage is within the acceptable range. If not, contact the local power operator. If yes, modify the grid overvoltage protection threshold through the WEB and APP with the consent of the local power operator.</li> <li>3. Check whether the peak voltage of the power grid is too high. If the alarm persists and cannot be rectified for a long time, contact the power operator.</li> </ol>
1014	AC-grid output overcurrent	Minor	The power grid voltage drops dramatically or the power grid is short circuited. As a result, the inverter transient output current exceeds the upper threshold, and protection is triggered.	<ol style="list-style-type: none"> <li>1. The inverter monitors its external operating conditions in real time and automatically recovers after the fault is rectified.</li> <li>2. If the alarm persists and affects the energy yield of the power plant, check whether the output is short circuited. If the fault persists, contact your dealer or technical support.</li> </ol>
1015	AC-backup output overcurrent	Minor	The backup load power exceeds the upper threshold.	<ol style="list-style-type: none"> <li>1. Try to reduce the load power;</li> <li>2. If it doesn't work out, contact your dealer or technical support.</li> </ol>
2001	Power module over temperature	Major	<ol style="list-style-type: none"> <li>1. The installation position of the battery power control module is not well ventilated.</li> <li>2. The ambient temperature is excessively high.</li> <li>3. The battery power control module is abnormal.</li> </ol>	<ol style="list-style-type: none"> <li>1. Check the ventilation and whether the ambient temperature of the power control module exceeds the upper threshold.</li> <li>2. If the ventilation is poor or the ambient temperature is excessively high, improve the ventilation and heat dissipation.</li> <li>3. If the ventilation and ambient temperature are normal, contact your dealer or technical support.</li> </ol>

Alarm ID	Alarm Name	Alarm Severity	Possible Cause	Trouble shooting
2002	Low battery DC input bus voltage	Major	<ol style="list-style-type: none"> <li>1. The DC bus voltage of the battery is low.</li> <li>2. The battery DC switch is OFF.</li> <li>3. The battery cables are not correctly connected.</li> </ol>	<ol style="list-style-type: none"> <li>1. If the alarm occurs occasionally, the power grid may be abnormal temporarily. The inverter automatically recovers after detecting that the power grid becomes normal.</li> <li>2. If the alarm persists, check whether the power grid voltage is within the acceptable range. If not, contact the local power operator. If yes, modify the grid overvoltage protection threshold through the WEB and APP with the consent of the local power operator.</li> <li>3. Check whether the peak voltage of the power grid is too high. If the alarm persists and cannot be rectified for a long time, contact the power operator.</li> </ol>
2003	Battery expansion module undervoltage	Major	The voltage of a battery expansion module is low.	If the sunlight insufficient or AC reverse charging is allowed, the battery expansion modules can be charged when the inverter is running.
2004	Power module reversely connected	Major	The positive and negative terminals are reversely connected when the power module connects to the inverter.	<ol style="list-style-type: none"> <li>1. Turn off the inverter AC output switch, inverter DC input switch, and battery DC switch, and wait for 5 minutes.</li> <li>2. Check the cable connections to the power control module by referring to the quick installation guide.</li> <li>3. After checking that the battery power cables are correctly connected, turn on the battery DC switch, AC output switch, and inverter DC input switch in sequence.</li> <li>4. If the alarm persists, contact your dealer or technical support.</li> </ol>
2005	Abnormal BMS communication	Major	The power module fails to communicate with the battery expansion modules.	<ol style="list-style-type: none"> <li>1. Turn off the battery DC switch.</li> <li>2. Check that the power cables and communications cables are correctly connected to the battery expansion modules.</li> <li>3. After checking that cables are correctly connected, turn on the battery DC switch.</li> <li>4. If the alarm persists, contact your dealer or technical support.</li> </ol>
2006	Equipment fault	Major	An unrecoverable fault occurs on a circuit inside the device.	Turn off the DC switch, and then turn them on after 5 minutes. If the alarm persists, replace the monitoring board or contact your dealer or technical support.
2007	Black start-up failed	Major	<ol style="list-style-type: none"> <li>1. The battery level is less than 10%.</li> <li>2. The energy storage DC switch is not turned on.</li> </ol>	<ol style="list-style-type: none"> <li>1. Turn off the PV switch and AC output switch, and wait for 1 minute for the device to turn off all LED lights.</li> <li>2. Turn on the PV switch and AC output switch, and start black again.</li> </ol>

Alarm ID	Alarm Name	Alarm Severity	Possible Cause	Trouble shooting
2008	Battery reversal connection	Major	Battery reversal connection	Check whether the battery is reversely connected to the power module. If so, turn off the DC switch and correct the battery polarity.
3001	Battery Pack Undervoltage	Minor	<ol style="list-style-type: none"> <li>1. The voltage of the battery pack or its cell is too low.</li> <li>2. The battery pack has been stored for a long period of time.</li> <li>3. The battery pack has been idle for a long time after grid connection.</li> </ol>	<ol style="list-style-type: none"> <li>1. Connect to the power grid and charge batteries in a timely manner.</li> <li>2. If the alarm persists after the battery has been charged for one hour, contact your dealer or technical support.</li> </ol>
3002	Battery module over temperature	Minor	<ol style="list-style-type: none"> <li>1. The battery installation position is not well ventilated.</li> <li>2. The ambient temperature is excessively high.</li> <li>3. The battery power control module is abnormal.</li> </ol>	<ol style="list-style-type: none"> <li>1. Check the ventilation and whether the ambient temperature of the battery expansion modules exceeds the upper threshold.</li> <li>2. If the ventilation is poor or the ambient temperature is excessively high, improve the ventilation and heat dissipation.</li> <li>3. If the ventilation and ambient temperature are normal, contact your dealer or technical support.</li> </ol>
3003	Battery module low temperature	Minor	<ol style="list-style-type: none"> <li>1. The ambient temperature is excessively low.</li> <li>2. A battery expansion module is abnormal.</li> </ol>	<ol style="list-style-type: none"> <li>1. Check whether the ambient temperature in the installation positions of the battery expansion modules is lower than the lower threshold.</li> <li>2. If the ambient temperature is excessively low, improve the installation environment.</li> <li>3. If the alarm persists after the ambient temperature becomes normal, contact your dealer or technical support.</li> </ol>

# 10.HANDLING THE INVERTER

## 10.1 Removing the inverter

### NOTICE

Before removing the inverter, power off the AC and DC (batteries).

Perform the following operations to remove the inverter:

1. Disconnect all cables from the inverter, including RS485 communications cables, DC input power cables, AC output power cables, and PGND cables.
2. Remove the inverter from the mounting bracket.
3. Remove the mounting bracket.

## 10.2 Packing the inverter

- If the original packing materials are available, put the inverter inside them and then seal them by using adhesive tape.
- If the original packing materials are not available, put the inverter inside a suitable cardboard box and seal it properly.

## 10.3 Disposing of the inverter

If the inverter service life expires, dispose of it according to the local disposal rules for electrical equipment waste.

# 11. TECHNICAL DATA

Model	M1-T5K	M1-T6K	M1-T8K	M1-T10K
<b>Input (PV)</b>				
Recommended max. PV power (Wp)	7500	9000	12000	15000
Max. input voltage (Vdc)	1000			
MPPT operating voltage range (Vdc)	160~800			
Start-up voltage (Vdc)	200			
Nominal input voltage (Vdc)	600			
Max. input current per MPPT (A)	14			
Max. short-circuit current (A)	16			
Number of MPP trackers	2			
Max. input number per MPP tracker	1			
<b>Input (Battery)</b>				
Battery Type	LiFePO <sub>4</sub> is the subscript			
Operating voltage range (Vdc)	600~980			
Max. operating current (A)	16.7			
Max. charge power (W)	10000	10000	10000	10000
Max. discharge power (W)	5000	6000	8000	10000
<b>Output (AC Grid)</b>				
Grid connection	Three phase			
Nominal output power (W)	5000	6000	8000	10000
Max. apparent power (VA)	5000	6000	8000	11000
Nominal output voltage (Vac)	220/380, 230/400, 3/ N/PE			
Nominal AC grid frequency (Hz)	50/60			
Nominal output current (A)	7.2	8.7	11.6	14.5
Max. output current (A)	8	9.6	12.8	16
Adjustable power factor	0.8 leading~0.8 lagging			
Max. total harmonic distortion	≤ 3 %			
<b>Output (AC backup)</b>				
Max,apparent AC power(VA)	5000	6000	8000	10000
Max. output current (A)	7.2	8.7	11.6	14.5
Nominal output power (VA)	5000	6000	8000	10000
Nominal output current (A)	7.2	8.7	11.6	14.5
Nominal output voltage (Vac)	220/380, 230/400, 3/ N/PE			
Switching to backup mode	<3s			
<b>Efficiency</b>				
Max. efficiency	97.6%	97.6%	97.6%	97.6%
<b>Protections &amp; Features</b>				
Input-side disconnection device	Yes			
Anti-Islanding protection	Yes			
DC reverse polarity protection	Yes			
Insulation monitoring	Yes			
Residual current monitoring	Yes			
AC overcurrent protection	Yes			

AC short-circuit protection	Yes
AC overvoltage protection	Yes
LVRT	Yes
Energy Management	Yes
Black start	Yes
Back-up power	Yes
<b>General Data</b>	
Operating temperature range	-25 ℃ ~ +60 ℃
Relative operating humidity	0 %RH~100 %RH
Max. operating altitude	2000m
Cooling	Natural convection
Display	LED indicators; integNominal WLAN + APP
Communication	RS485, WLAN
Weight (kg)	33.6
Dimension (W×H×D)(mm)	521×516×196
Degree of protection	IP65
<b>Standard Compliance</b>	
EMC	EN 61000-6-1,EN 61000-6-3,EN 62920
Safety	IEC62109-1, IEC62109-2

# TRADEMARKS, COPYRIGHTS AND LEGAL STATEMENT

 Midea logo, word marks, trade name, trade dress and all versions thereof are valuable assets of Midea Group and/or its affiliates (“Midea”), to which Midea owns trademarks, copyrights and other intellectual property rights, and all goodwill derived from using any part of an Midea trademark. Use of Midea trademark for commercial purposes without the prior written consent of Midea may constitute trademark infringement or unfair competition in violation of relevant laws.

This manual is created by Midea and Midea reserves all copyrights thereof. No entity or individual may use, duplicate, modify, distribute in whole or in part this manual, or bundle or sell with other products without the prior written consent of Midea.

All the described functions and instructions were up to date at the time of printing this manual. However, the actual product may vary due to improved functions and designs.

## DISPOSAL AND RECYCLING

### **Important instructions for environment(European Disposal Guidelines)**

Compliance with the WEEE Directive and Disposing of the Waster Product:  
This product complies with EU WEEE Directive. This product bears a classification symbol for waster electrical and electronic equipment (WEEE).

This symbol indicates that this product shall not be disposed with other household wastes at the end of its service life. Used device must be returned to official collection point for recycling of electrical electronic devices. To find these collection systems please contact to your local authorities or retailer where the product was purchased. Each household performs important role in recovering and recycling of old appliance. Appropriate disposal of used appliance helps prevent potential negative consequences for the environment and human health.

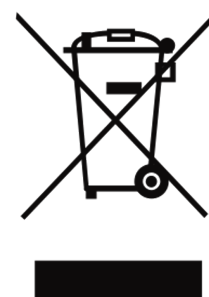

# DATA PROTECTION NOTICE

For the provision of the services agreed with the customer, we agree to comply without restriction with all stipulations of applicable data protection law, in line with agreed countries within which services to the customer will be delivered, as well as, where applicable, the EU General Data Protection Regulation (GDPR).

Generally, our data processing is to fulfil our obligation under contract with you and for product safety reasons, to safeguard your rights in connection with warranty and product registration questions. In some cases, but only if appropriate data protection is ensured, personal data might be transferred to recipients located outside of the European Economic Area.

Further information are provided on request. You can contact our Data Protection Officer via **MideaDPO@midea.com**. To exercise your rights such as right to object your personal data being processed for direct marketing purposes, please contact us via **MideaDPO@midea.com**. To find further information, please follow the QR Code.

The design and specifications are subject to change without prior notice for product improvement. Consult with the sales agency or manufacturer for details. Any updates to the manual will be uploaded to the service website, please check for the latest version.











*make yourself at home*



[www.midea.com](http://www.midea.com)

© Midea 2023 all rights reserved

1611460000061

20231225

## 备注说明：

- 1.基准说明书按集团OBM产品要求，模板统一按集团要求设计，说明书中会根据基准产品的信息。基准说明书只含基准机型信息，不包含订制机型信息。
- 2.基准说明书封面设计了型号，按制单要求，以XXXXXX形式体现。说明书中最后的内容：TRADEMARKS, COPYRIGHTS AND LEGAL STATEMENT, DATA PROTECTION NOTICE以及制造商信息都为基准。需要业务和制单工程师根据客户实际信息以及认证进行更改替换。
- 3.基准说明书不能直接使用到机型上，必须由制单按实际生产信息进行更改，基准说明书仅供制单参考。

## 说明书技术条件：（此页无需印刷）

材质：80克双胶纸  
颜色：黑白  
尺寸：210\*290  
装订：骑马钉